

CONNEXT[®] METALBESTOS[®]

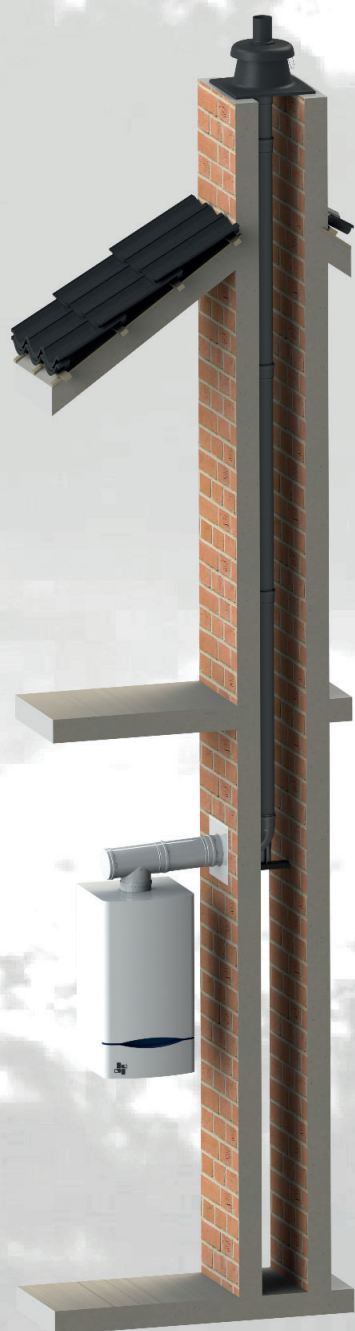

Produktoversigt

Aftrækssystemer til
Olie- og gasfyr

Typiske kedelafttræks løsninger

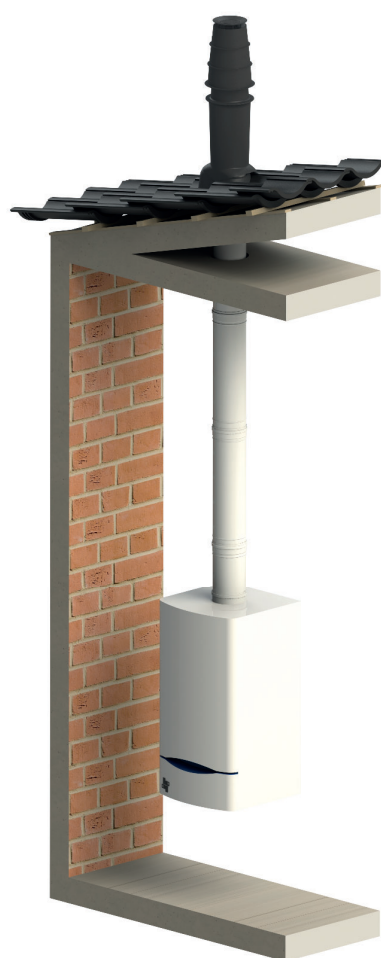

Maks aftrækslængder:

Følg **altid** kedelleverandørens anvisninger.

Med specialløsninger kan der udføres beregninger på disse.

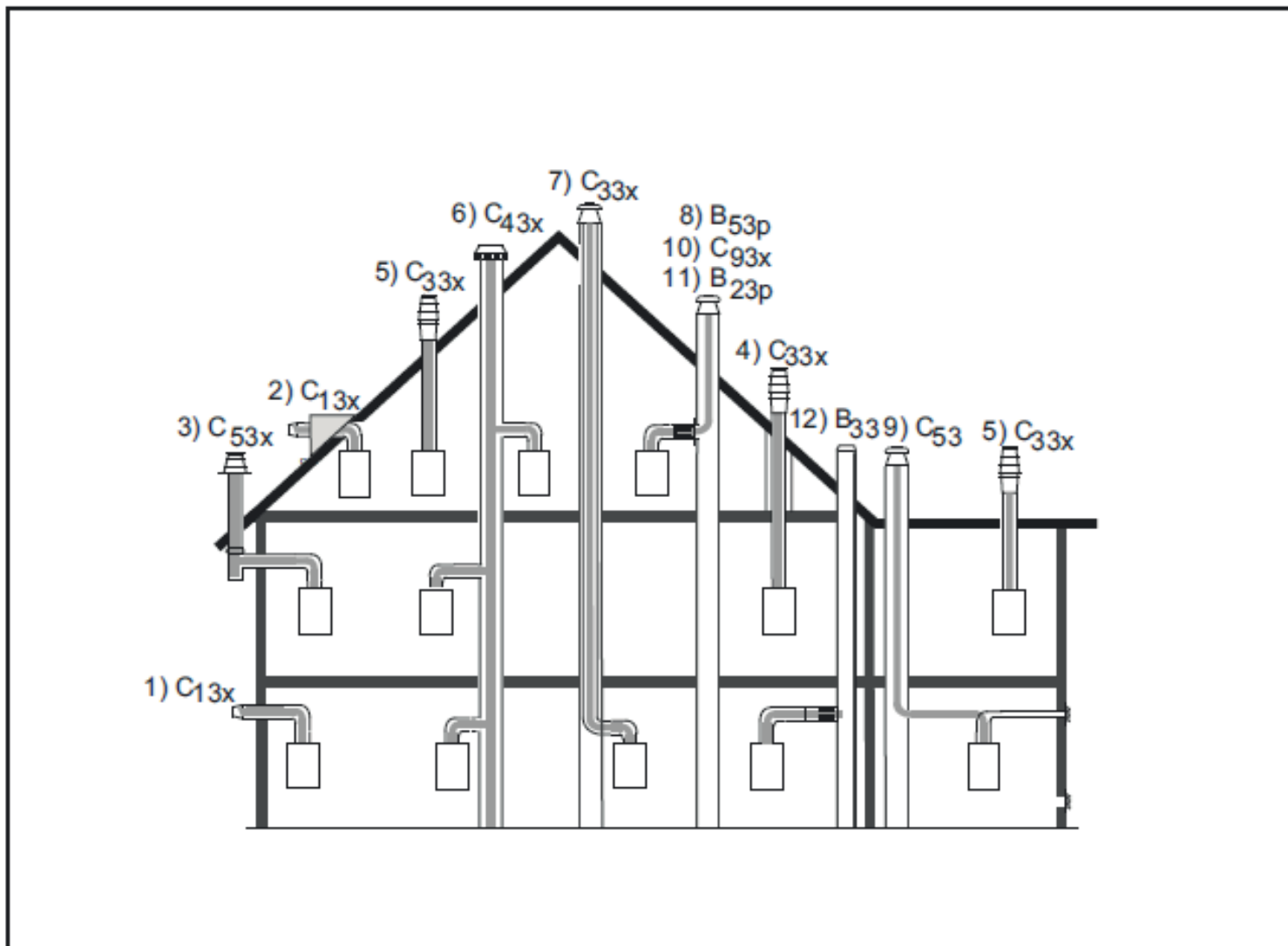

Aftræksslængder

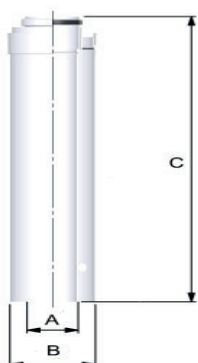

VVS Nr.	A	B	C
3429 05 060	60	100	500
3429 05 080	80	125	500
3429 05 110	110	160	500
3429 07 060	60	100	1000
3429 07 080	80	125	1000
3429 07 110	110	160	1000

Aftræksslængde med rensedør



VVS Nr	A	B	C
3429 14 060	60	100	250
3429 14 080	80	125	270
3429 14 110	100	160	270

Vinkel-stykker 15°

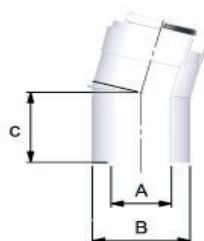

VVS Nr	A	B	C
3429 21 060	60	100	85
3429 21 080	80	125	100

Vinkel-stykker 30°

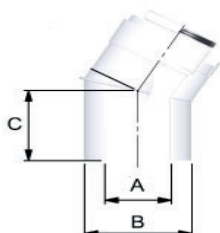

VVS Nr	A	B	C
3429 22 060	60	100	85
3429 22 080	80	125	100

Vinkel-stykker 45°

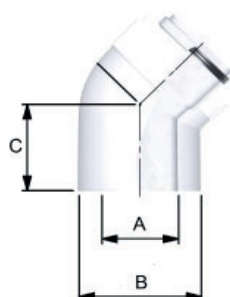

VVS Nr	A	B	C
3429 23 060	60	100	70
3429 23 080	80	125	90
3429 23 110	110	160	110

Vinkel-stykker 87°

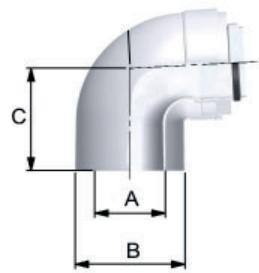

VVS Nr	A	B	C
3429 24 060	60	100	120
3429 24 080	80	125	130
3429 24 110	110	160	163

Vinkel-stykker 87° med rensedør

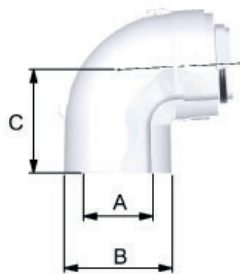

VVS Nr	A	B	C
3429 25 060	60	100	120
3429 25 080	80	125	130
3429 25 110	110	160	163

Inspektions T-stykke 87°

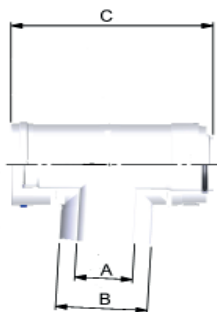

VVS Nr	A	B	C
3429 26 060	60	100	250
3429 26 080	80	125	270
3429 26 110	110	160	303

Spærstyr alu.

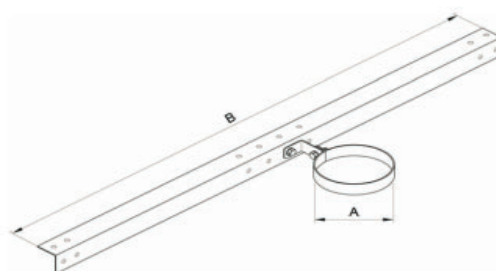

VVS Nr	A	B
3429 29 060	100	1000
3429 29 080	125	1000
3429 29 110	160	1000

Membran gennemføring

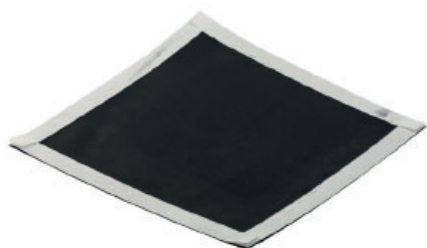

VVS Nr	A	B
3429 34 080	250	250
3429 34 110	400	400

Tagindækning (Alu)

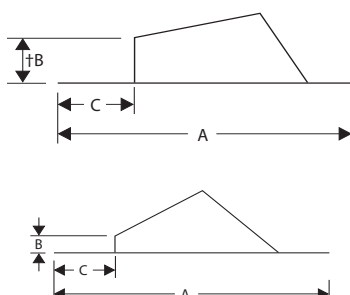
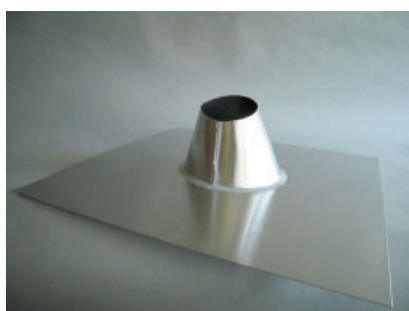

60/100mm - 80/125mm			
VVS Nr.	A	B	C
3429 35 080	750	180	230
3429 36 080	750	140	200
3429 38 080	750	160	280

Flad tag 38 xxx
 Hældning 5° - 32° 35 xxx
 Hældning 33° - 45° 36 xxx

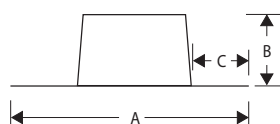

110/160mm			
VVS Nr.	A	B	C
3429 35 110	750	130	210
3429 36 110	750	90	180
3429 38 110	750	160	250

Tagindækning (Flex)

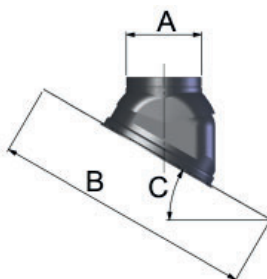
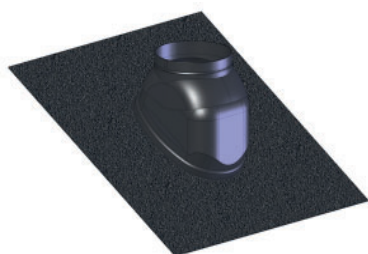

60/100mm - 80/125mm			
VVS Nr.	A	B	C
3429 35 126	130	1000	5°-45°
3429 36 496	130	1000	25°-45°

110/160mm			
VVS Nr.	A	B	C
3429 35 526	165	1000	25°-45°
3429 36 526	165	1000	25°-45°

Tilslutning til skorsten C93 (L4)



VVS Nr	A	B
3429 69 060	250	250
3429 69 080	250	250
3429 69 110	250	250

Frisk luft gennem eks. skorsten

Tilslutning til skorsten B33 (L3)



VVS Nr	A	B
3429 70 060	250	250
3429 70 080	250	250
3429 70 110	250	250

Frisk luft fra opstillingsrummet

Vægforankring for facadeaftræk

VVS Nr	A
3429 71 180	125



Taggennemføring C33

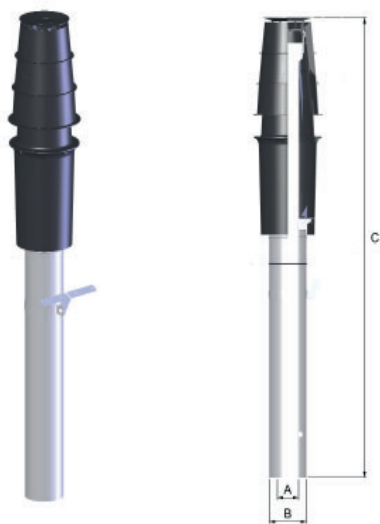

VVS Nr	A	B	C
3429 73 061	60	100	1151
*3429 73 071	60/80	100/125	1151
3429 73 081	80	125	1151
3429 73 111	110	160	1151

* inkl. reduktion

Væggennemføring C13

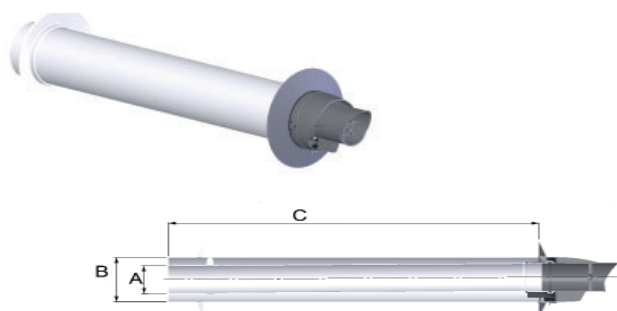

VVS Nr	A	B	C
3429 74 060	60	100	800
*3429 74 070	60/80	100/125	800
3429 74 080	80	125	800
3429 74 110	110	160	800

* inkl. bøjning m/inspektion

Fuglerist



VVS Nr	A
3429 77 060	60
3429 77 080	80
3429 77 110	110

Loftkrav (hvid) 11 - 38° 2-delt

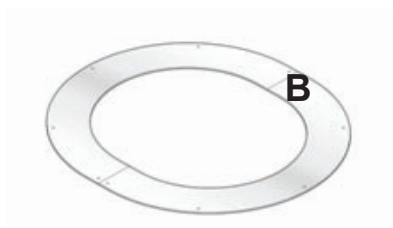

VVS Nr	A	B
3429 82 060	60	50
3429 82 080	80	90
3429 82 110	110	50

Roset (hvid) PPS 0 - 10°

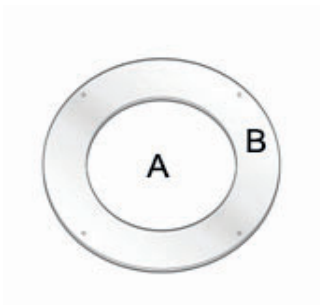

VVS Nr	A	B
3429 84 060	100	30
3429 84 080	125	50

Loftkrav (hvid) 0 - 10°

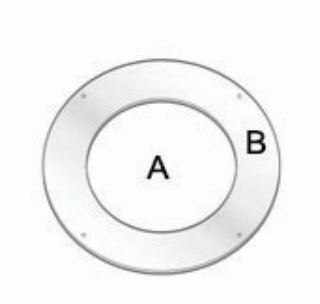

VVS Nr	A	B
3429 85 110	160	90

Split adaptor



VVS Nr	A	B	C
3429 95 060	60	100	150
3429 95 080	80	125	170
3429 95 110	110	160	170

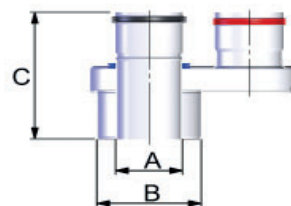

Målepunkt

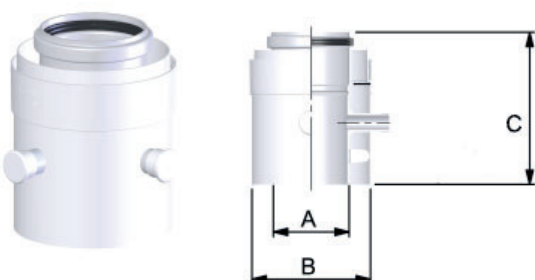

VVS Nr	A	B	C
3429 99 060	60	100	250
3429 99 080	80	125	250
3429 99 110	110	160	250

Enkelt rør

Aftrækslængder

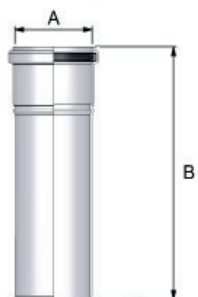

VVS Nr	A	B
3429 05 070	60	500
3429 07 070	60	1000
3429 05 090	80	500
3429 07 090	80	1000
3429 05 120	110	500
3429 07 120	110	1000
3429 05 170	160	500
3429 07 170	160	1000
3429 05 210	200	500
3429 07 210	200	1000
3429 08 070	60	1950
3429 08 090	80	1950

Aftrækslængde med rensedør



VVS Nr	A	B
3429 14 070	60	270
3429 14 090	80	270
3429 14 120	110	270
3429 14 170	160	270
3429 14 210	200	270

Vinkel-stykker 15°



VVS Nr	A
3429 21 070	60
3429 21 090	80
3429 21 120	110
3429 21 170	160
3429 21 210	200

Vinkel-stykker 30°



VVS Nr	A
3429 22 070	60
3429 22 090	80
3429 22 120	110
3429 22 170	160
3429 22 210	200

Vinkel-stykker 45°

VVS Nr	A
3429 23 070	60
3429 23 090	80
3429 23 120	110
3429 23 170	160
3429 23 210	200

Vinkel-stykker 87°

VVS Nr	A
3429 24 070	60
3429 24 090	80
3429 24 120	110
3429 24 170	160
3429 24 210	200

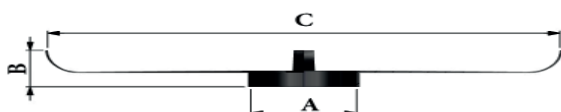
Styrebeslag til fastrør (pakke af 2)

VVS Nr	A	B	C
3429 62 070	60	45	400
3429 62 090	80	45	400
3429 62 120	110	45	400
3429 62 170	160	45	400
3429 62 210	200	45	400

Vinkel-stykker 87° m/bæring

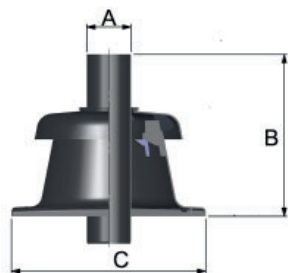

VVS Nr	A
3429 63 070	60
3429 63 090	80
3429 63 120	110
3429 63 170	160
3429 63 210	200

Skorstensafslutning B33/C93 (L3/L4)

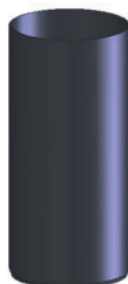

VVS Nr	A	B
3429 68 070	60	350
3429 68 090	80	350
3429 68 120	110	350

Rør UV bestandig 345mm sort



VVS Nr	A	B
3429 75 070	60	345
3429 75 090	80	345

UV reparationskit m/muffe 250mm sort



VVS Nr	A	B
3429 76 070	60	250
3429 76 090	80	250

Grundpakke C93 (enkelt rør)



Grundpakke består af:

- 2 styrebeslag - 342962xxx
- 1 skorstensafslutning - 342968xxx
- 1 87° vinkelstykke - 342963xxx

Grundpakke til facadeaftræk C53

342971080 bestående af:

- 2 stk vægforankring
- 2 stk vægroset
- 1 stk murgennemføring
- 1 stk aftrækstop
- 1 stk vægbæring
- 1 stk T-stykke m/vinkel og bundprop
- 1 stk luftindtag





VVS Nr	A
3429 32 065	60
3429 32 085	80
3429 32 115	110

Grundpakken består af:
 5 stk styrebeslag
 1 stk overgang t/flex rør
 1 stk skorstensafslutning inkl. overgang fra flex rør
 1 stk 87° vinkel med bæring
 pakning/glidemiddel/ 4 skruer m/plugs

Flexrør

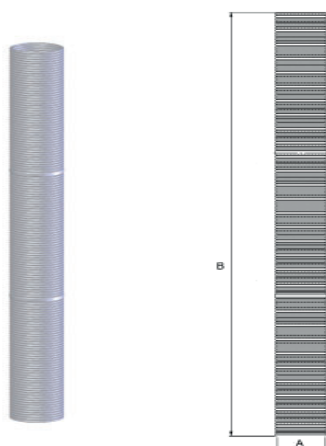

VVS Nr	A	B
3429 51 065	60	12,5 mtr
3429 51 085	80	12,5 mtr
3429 52 115	110	15 mtr
3429 53 065	60	25 mtr
3429 53 085	80	25 mtr
3429 53 115	110	25 mtr

Aftrækslængde med rensdør



VVS Nr	A	B
3429 14 065	60	310
3429 14 085	80	310
3429 14 115	110	310

Styrebeslag til flexrør (pakke af 5)

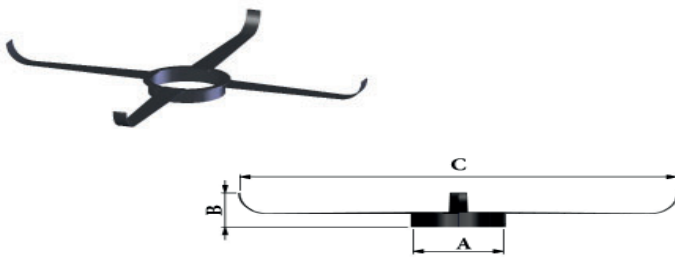

VVS Nr	A	B	C
3429 62 065	60	45	400
3429 62 085	80	45	400
3429 62 115	110	45	400

Kobling til flexrør

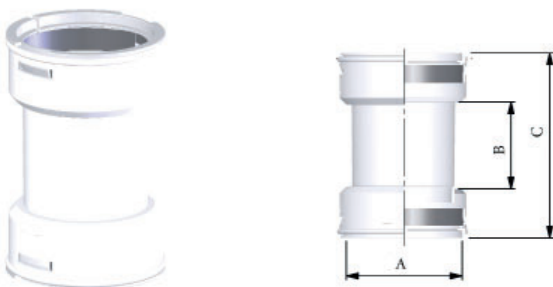

VVS Nr	A	B	C
3429 94 065	60	100	240
3429 94 085	80	100	240
3429 94 115	110	100	240

Værktøj til flexrør

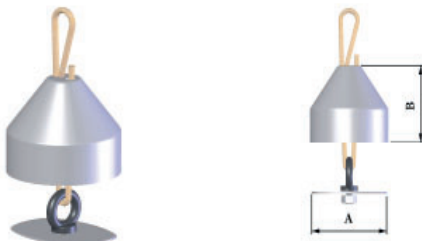

VVS Nr	A	B	C
3429 97 065	60	95	55
3429 97 085	80	95	55
3429 97 115	110	95	55

Overgang 80/125 - 60/100

VVS Nr
3429 95 063

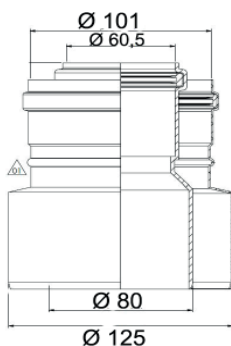

Overgang 80/125 - 60/100 i vinkel m/rens

VVS Nr
3429 95 065









CONNEXT[®]

Næste skridt

Skriv til os vedrørende yderligere info, ønsker og behov eller ring til os.

Vi vil med glæde vejlede i mulighederne, sende tekniske specifikationer eller lave en beregning.

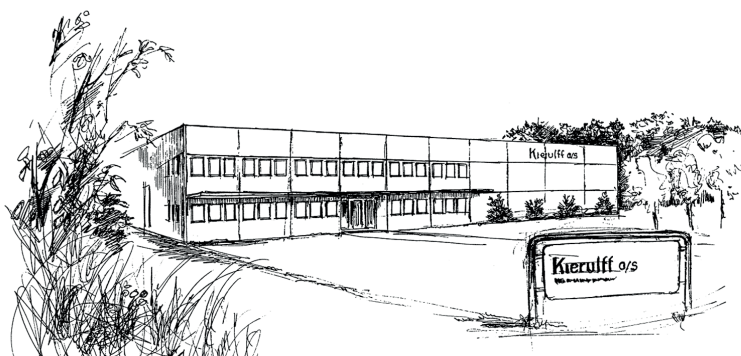

Kierulff a/s

VVS Kvalitet fra Langeland

info@kierulff.dk

www.kierulff.dk

+45 62 50 11 50