

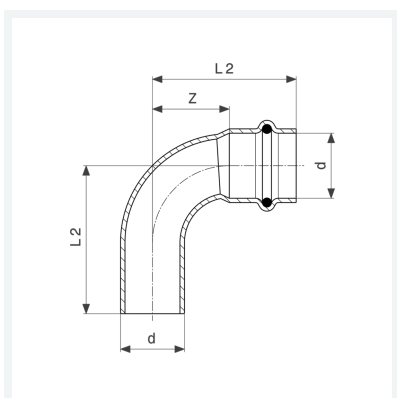

Seapress bøjning 90°
- prestilslutning, indstiksende

Udstyr
EPDM pakning
model 0316.1

art.nr. 453 664



Egenskaber

Udvendig rørdiameter	d	42
Z-mål	Z	50 mm
Længde 1	L1	86 mm
Længde 2	L2	90 mm
Vægt	278 g	
Vægt	353 g	
Volume	621,6 cm ³	
Materiale	CuNiFe	