

767.403.110 S INDUSTRIAFLØB, LAV

- Gulv: beton og fliser
- Smøremembran, ramme: 300x300 mm
- Udløb: Ø110 mm, lodret
- Syrefast stål: AISI316L/EN1.4404

Produktkoder

EAN: 5705499110791
VVS nummer: 153002346
LVI nummer: 3303717

Specifikation

Antal sideindløb: 0
Antal skruehuller: 0
Betegnelse: 300x300
Gulv: Beton / fliser
Materiale: AISI 316L
Materiale (EN): EN 1.4404
Membran: Smøremembran
Ramme: Kvadratisk
Type: Afløb
Udløbsdiameter (mm): 110
Udløbsretning: Lodret

Godkendelser

 DK - VA 2.42/19497-21

PL - Hygienic Certificate - All products
US - NSF
RU - 0212321 Drains-21

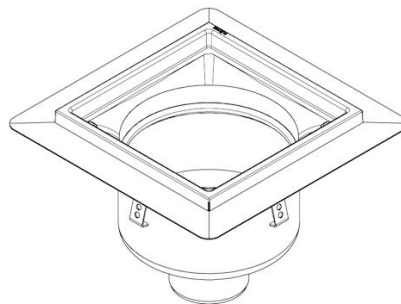
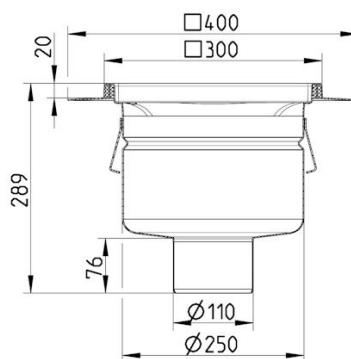

BLÜCHER®