

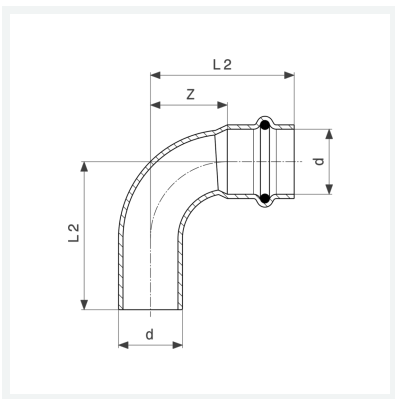

Seapress bøjning 90°
- prestilslutning, indstiksende

Udstyr
EPDM pakning
model 0316.1

art.nr. 453 244



Egenskaber

Udvendig rørdiameter	d	28
Z-mål	Z	34 mm
Længde 1	L1	58 mm
Længde 2	L2	60 mm
Vægt	118 g	
Vægt	119 g	
Volume	207,2 cm ³	
Materiale	CuNiFe	