

**INSTALLATIONSVEJLEDNING  
MONTAGEANWEISUNG  
INSTALLATION INSTRUCTION  
INSTRUCTIONS D'INSTALLATION  
INSTALLATIE INSTRUCTIES  
ISTRUZIONI DI INSTALLAZIONE  
INSTRUCCIONES DE INSTALACIÓN**

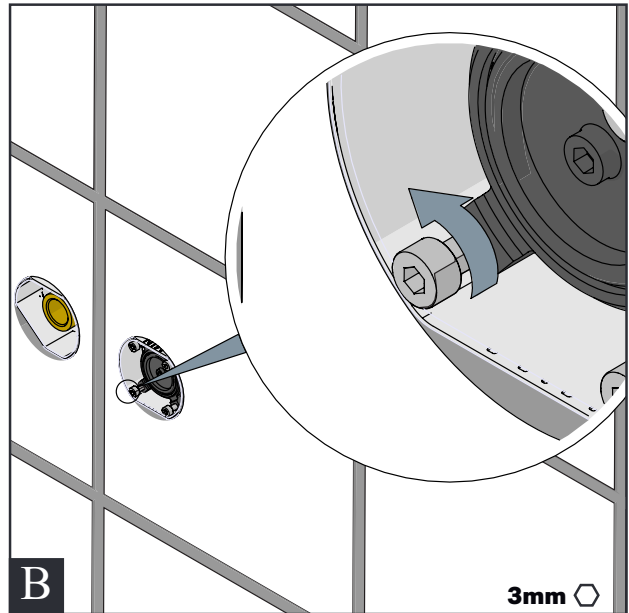

Rev. 001  
2022-10-11  
2030000

**CONCEALED**  
Basin Mixer

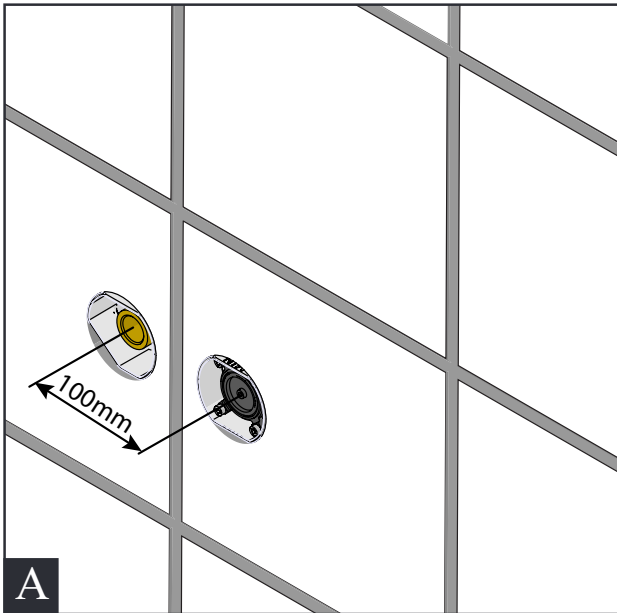

**INSTALATION**

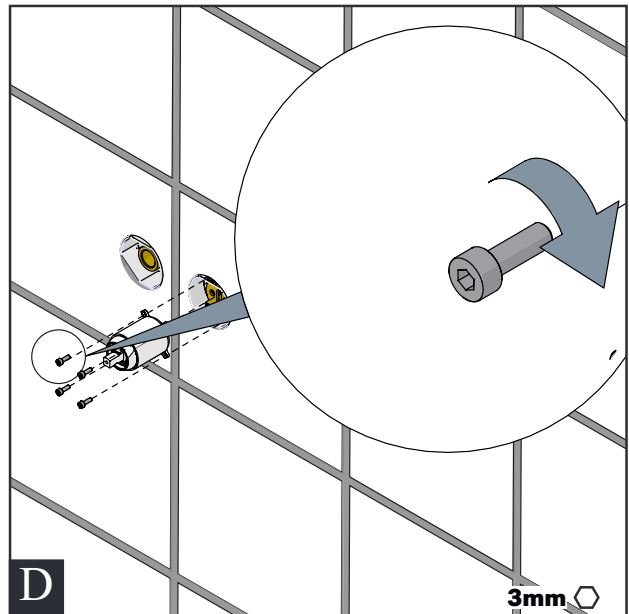
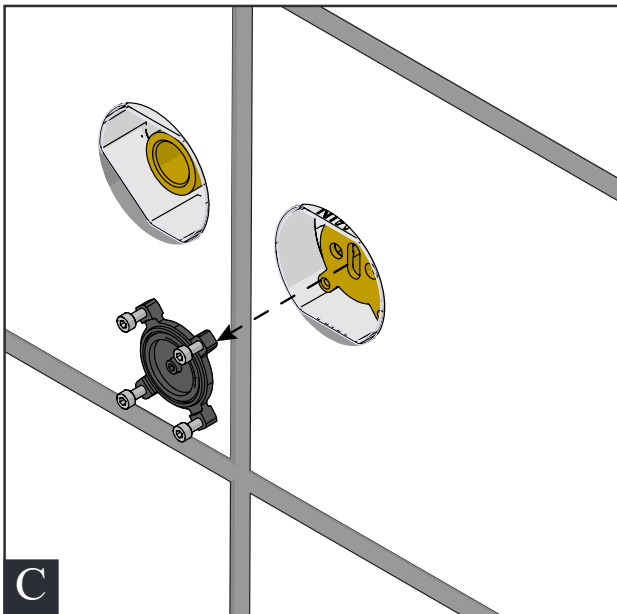

**FM Mattsson Denmark ApS**  
Hvidkærvej 48, 5250 Odense SV  
Abildager 26a, 2605 Brøndby  
Tlf. +45 88 33 00 34  
damixa-international@fmmattssongroup.com  
www.damixa.com

**damixa**

# INSTALLATION

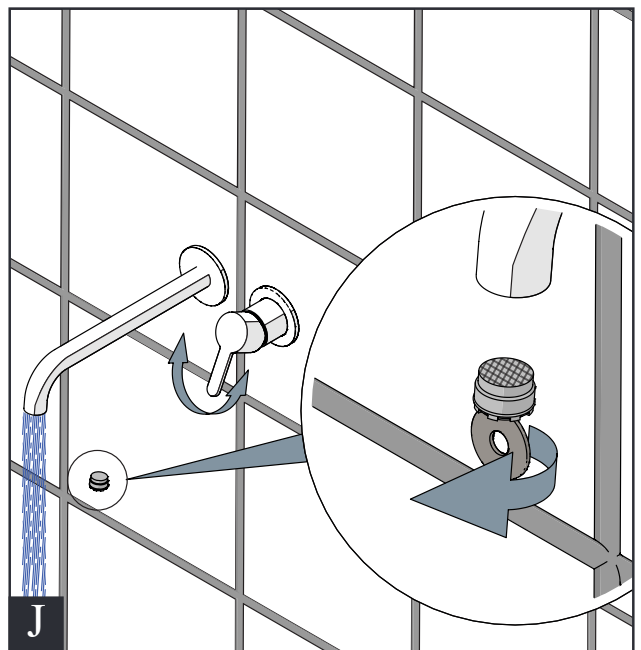
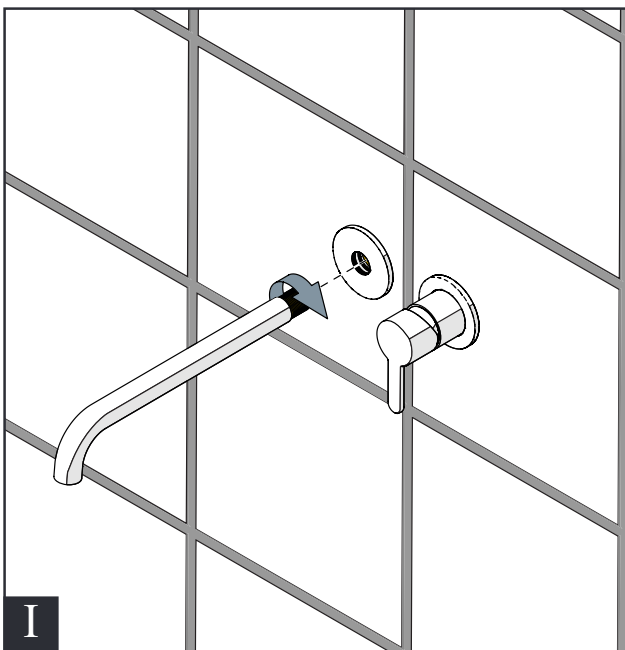
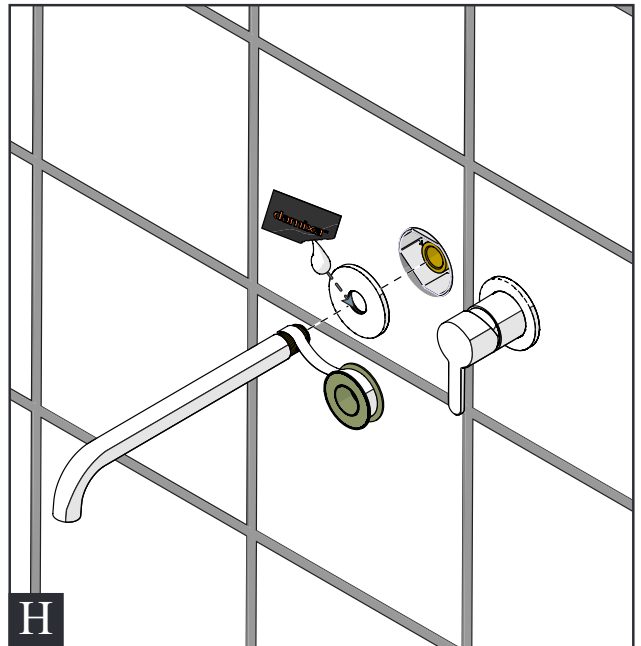
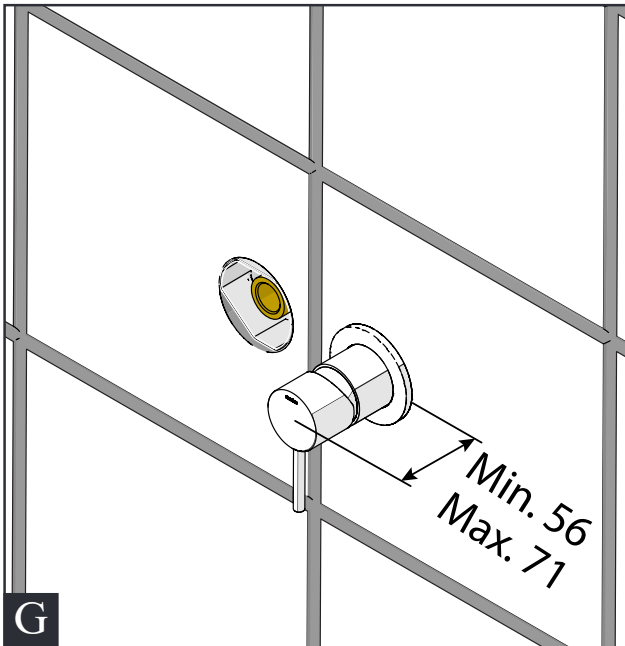
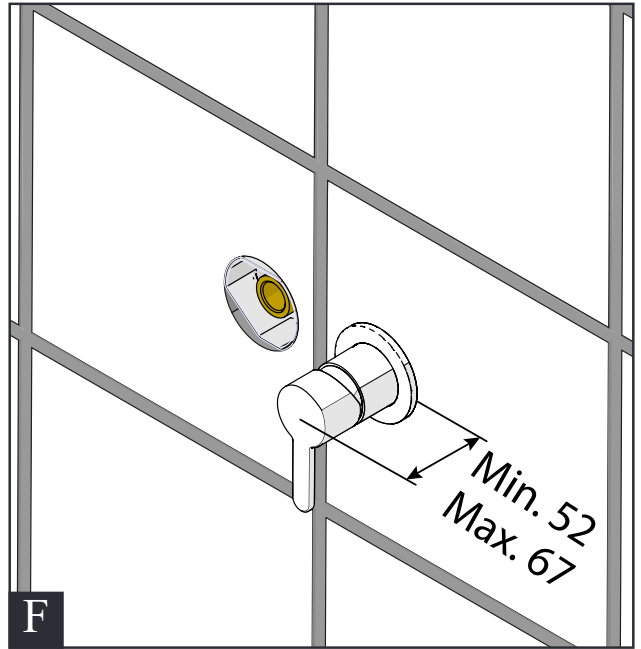
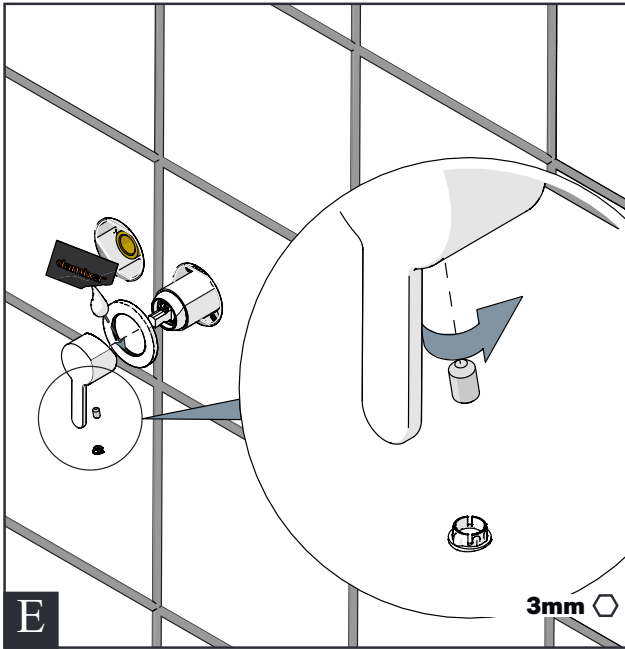

# INSTALLATION

