

WAVIN AS+
Technical Manual

low noise soil & waste drainage



Contents

1. Wavin AS+	page	4
1.1. System description	page	4
1.2. Field of application	page	5
1.3. Chemical resistance	page	6
2. Technical datasheet Wavin AS+	page	7
3. Acoustics	page	8
3.1. Sound insulation by Wavin AS+	page	8
3.2. Noise calculation software	page	8
3.2.1. Wavin soundcheck tool	page	10
3.3. Sound-insulating performance	page	11
3.4. About sound	page	12
3.5. Noise	page	12
3.5.1. Sources of noise in buildings	page	14
3.5.2. How noise is measured	page	14
3.6. Acoustic requirements	page	15
3.7. Acoustic design	page	16
3.7.1. Advantageous layout	page	16
3.7.2. Acoustic plumbing design	page	17
4. Design of the waste water system	page	18
4.1. Installation and layout principles for waste water drainage systems	page	18
4.2. List of definitions according to standard	page	19
4.3. Functional requirements	page	21

5. Installation and jointing	page 44
5.1. Connecting Wavin AS+ to fittings and pipes	page 44
5.2. General bracketing rules	page 50
5.2.1. Bracket fixing instruction	page 50
5.2.2. Bracket arrangement	page 50
5.2.3. Max length of threaded rod	page 52
5.2.4. Extended wall distance	page 3
5.3. Low noise installation – bracketing types	page 53
5.3.1. Low noise bracketing – single bracket	page 54
5.3.2. No noise bracketing – double bracket	page 55
6. Fire protection	page 56
6.1. Fire behavior classification	page 56
6.2. Fire resistance classification	page 56
6.3. Wavin fire protection concept	page 57
6.4. Assembly instruction	page 57
7. Packing, Transport & Storage	page 62
8. Wavin AS+ Product Range	page 63
Annex I Chemical resistance list	page 78
Annex II Specification text	page 81

1. Wavin AS+

1.1. System description

With regards to noise, Wavin is one of the pioneers. More than 30 years ago Wavin introduced the world's first plastic low noise Soil & Waste system.

After serving its purpose for more than 30 years, Wavin is introducing the successor of Wavin AS and is setting a new standard for low noise Soil & Waste solutions.

Wavin AS+ is the new best in class plastic sound-insulating Soil & Waste piping system, suitable for drainage of hot and cold waste water and in accordance with all requirements for non-pressurized waste water piping as laid down in DIN EN 12056 and DIN 1986-100.

Wavin AS+ reduces the noise level of the Soil & Waste system better than any other plastic pipe system.

Due to the unique material composition for improved noise performance, premium reduction of unwanted sound emissions by the drainage system inside the building is assured. Optimal sound reduction is guaranteed due to high density of material.

Wavin AS+ is a mineral reinforced polypropylene (PP) low noise soil and waste solution.

Wavin AS+ is available in sizes ranging from DN 50 to DN 200.

Like all plastics, Wavin AS+ is durable, corrosion-resistant and able to withstand the chemical attack of all kinds of aggressive waste waters.

Although the system has been primarily designed as sound-insulating Soil & Waste solution, Wavin AS+ is also approved for underground as far as the main sewer connecting point.

Supported by the DIN EN 12056 and DIN 1986-100 waste water norms, which further endorse DN 90 downpipe specifications – from the individual waste water sources (facilities) right up to the main drain cleaning access point or the main sewage connecting point.

The new Wavin AS+ has been designed to meet the needs of engineers and installers. On top of 30 years of experience, we spent over a hundred thousand hours on noise level testing, explored new materials and invested heavily in developing a seal that needs no lubricant. This is why we can confidently say that the ultimate noise reduction and super easy installation delivered by the new Wavin AS+ is no coincidence.

Wavin AS+ includes unique product features that are contributing to the ease and safety of an installation:

- ⦿ New patented blue seal means no need to lubricate
- ⦿ Sculptured spigot reduces push-in force with 50% compared to Wavin AS
- ⦿ Blue seal's shape guarantees leak-free, failure-proof installation
- ⦿ Unique material, composition delivers, perfect sound absorption
- ⦿ Angular rotation guidance to align and rotate fittings in the right direction
- ⦿ Insertion depth check to make a secure and safe connection
- ⦿ Better handling during installation due to the grip features
- ⦿ Compact design perfect for small and narrow spaces

Sealing

The elastomeric seal is made from EPDM in conformity with EN681-1.

Approvals and testing

Wavin AS+ pipes and fittings are continually subject to strict quality controls according to DIBt in Berlin. Wavin AS+ pipes & fittings have been awarded DIBt buildings' inspection approval (DIBt Z-42.1-569) and are, therefore, deemed suitable for use as above and below-ground pipework. Germany: DiBt, Z.-42.1-569

1.2. Field of application

Areas of application

Wavin AS+ is resistant to hot water and fulfills or exceeds all the requirements of DIN EN 12056 and the associated norms given in DIN 1986-100, i.e. short-term exposure to temperatures of 95°C and long-term exposure to temperatures of 90°C.

The chemical resistance of Wavin AS+ makes it suitable for transporting waste water in the range pH 2 - 12.

Wavin AS+ is suitable for building, roof and below ground drainage purposes.

The outstanding acoustic performance of WAVIN AS+ makes it ideal for wherever DIN 4109-compliant sound insulation might be required, such as in hospitals, hotels, nursing homes, office buildings, or single/multi-occupancy residential properties.

Noise pollution affects both health and behavior.

Exposure to noise can effect both health and behavior. Unwanted sound (noise) can damage physiological health. It can cause hypertension, high stress levels, tinnitus, hearing loss, sleep disturbances, and other harmful effects. It is for this reason that modern buildings are equipped with a range of sound-insulation measures designed to favour comfortable living, such as thick exterior walls and soundproofed windows. But we often forget that noise is not just external; it can also be generated from inside the building. Wavin wants to create better buildings. Wavin AS+ is a premium-quality, sound-insulating pipe system designed to minimise noise from plumbing systems and maximise living comfort.

Commercial kitchens and abattoirs

Wavin AS+ is ideal draining fat-containing waste water from e.g. commercial kitchens and abattoirs. Long-term functional reliability and temperature resistance (continuous exposure up to 90°C / short-term up to 95°C in accordance with DIN EN 12056 / DIN 1986-100) are fundamental requirements here. The smooth internal surface of the pipe prevents incrustations. When installing Wavin AS+ in commercial kitchen and abattoirs with high fat-containing waste water, the use of NBR sealing rings is advised. If fat-containing waste waters need to cover a long distance before reaching the grease-trap

facilities, the premises have to be equipped with an auxiliary electric heating system designed to keep the waste water in a liquid state, while maintaining a temperature of no more than 70°C.

Photographic laboratories

Wavin AS+ pipes and fittings – made of mineral-reinforced PP and supplied with factory-fitted sealing rings – are resistant to the developing and fixing media used in photographic laboratories over long-term exposures at 60°C. They are also approved for short-term temperature loads of up to 95°C. (Please refer to the Chemical Resistance List in the annex for further details).

It is recommended that piping is installed with sufficient fall to reduce the contact time between fluid and guiding surface to a minimum.

Dental practices

Wavin AS+ can be used unreservedly in dental practices, provided the piping downstream of the dentist's chair is fitted with an integrated amalgam separator. Wavin AS+ (including the sealing rings) is resistant to dental amalgam. In addition, cleaning agents and disinfectants normally used in dental practices, if present in the usual concentrations, are harmless to the pipe system.

Food-processing and chemical industries

Usage with waste water containing lactic acid from the food sector and chemical industry, Wavin AS+ pipes and fittings are resistant to media containing lactic acid (at concentrations up to 90%) at liquid temperatures up to 60°C. This also applies to the factory-fitted EPDM sealing ring that form part of the push-fit connecting system, especially as contact is marginal. It is recommended that piping is installed with sufficient fall to reduce contact time to a minimum.

1.3 Chemical resistance

The data in the chemical resistance list is intended only as a guide for planning purposes and are not automatically applicable to all conditions of use. Considerable deviations can occur dependent on type of exposure and probable contamination of the chemical medium. Wavin cannot be held liable for any special, indirect or consequential damages irrespective of whether caused or allegedly caused by negligence. No warranty can be derived concerning the data mentioned.

For the complete chemical resistance list see Annex I.

2. Technical datasheet

Wavin AS+

Wavin AS+ is a mineral reinforced polypropylene (PP) low noise soil and waste solution. A unique material composition for improved noise performance. Optimal sound reduction is guaranteed due to high density of material. Optimized three layer pipe structure for low noise levels push fit connections with a prelubricated elastomer seal (EPDM) for quick, easy and reliable installation.

Material

Polypropylene, mineral-reinforced.

Physical properties

⊕ Density	~ 1,9 g/cm ³
⊕ E-Modul	~ 1800 N/mm ²
⊕ Linear coefficient of thermal expansion	~ 0,06 mm/mK
⊕ Reaction to fire	DIN 4102, B2 and EN13501 D-S3, d0
⊕ Temperature	Short-time load by 95°C und 90°C long-term stress

Color

Light grey RAL7035

Pipe data

DN	d ¹⁾	di ²⁾	s ³⁾
50	50	44	3,0
70	75	68	3,5
90	90	80,8	4,6
100	110	99,4	5,3
125	125	114,4	5,3
150	160	148,8	5,6
200	200	188	6,0

¹⁾ Outside diameter in mm

²⁾ Inside diameter in mm

³⁾ Wall thickness in mm

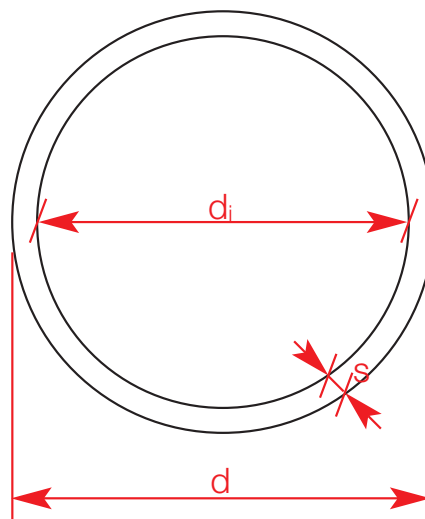

Marking

Wavin AS+, nominal width,, date, certification mark, material, fire class

Example: Wavin AS+, DN 100, date, Z.-42.1-569, mineral-reinforced PP Ü DIN 4102, B2

3. Acoustics

3.1. Sound insulation by Wavin AS+

The excellent sound protection properties of Wavin AS+ are primarily attributed to its thick-walled design as well as special molecular structure and the high density of $\sim 1.9 \text{ g/cm}^3$ of the material. This property enables Wavin AS+ to absorb airborne sound as well as mechanical vibrations.



A contribution to sound protection is made by the special product design and system solutions.

- ⦿ Swept branches for minimal flow disturbance in the down pipe.
- ⦿ Due to unique system bracket and high structure born sound prevention



Fig. 1: Double branch.



Fig. 2: Wavin System bracket.

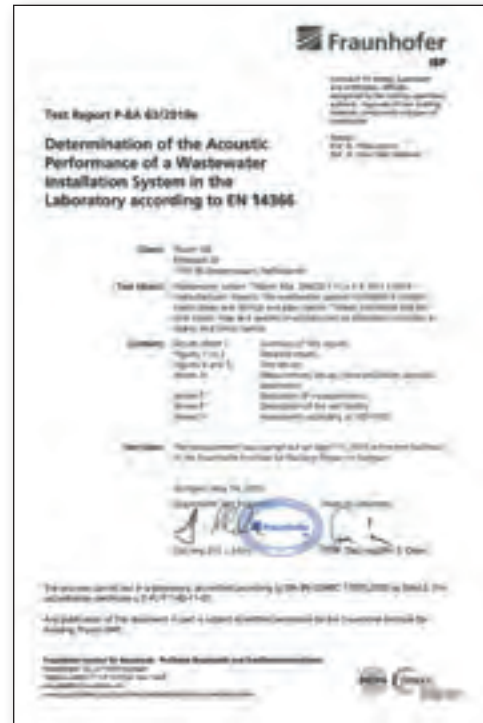

In studies conducted at the Fraunhofer Institut für Bauphysik (Fraunhofer Institute for Building Physics), Stuttgart, Wavin AS+ has proven its excellent sound absorption properties. The tests were performed in a laboratory accredited by the German Accreditation System for Testing (DAP, file no. PL-3743.26) according to standard EN ISO/IEC 17025.

The measurements in this test were performed following German standard DIN EN14366 and DIN 52 219:1993-07; noise excitation by stationary water flow with 0.5 l/s, 1.0 l/s, 2.0 l/s., 3.0 l/s and 4.0 l/s.

3.2. Noise calculation software

Determination of the sound level as conducted by Fraunhofer Institut Bauphysik is in general useful to determine the noise level of a pipe system in a static situation. The test method is, however, based on a laboratory set up in which all building parameters are kept the same except for a change in water flow. As a result it is impossible to obtain by this test a realistic figure of the noise levels for the protect chambers of actual projects.

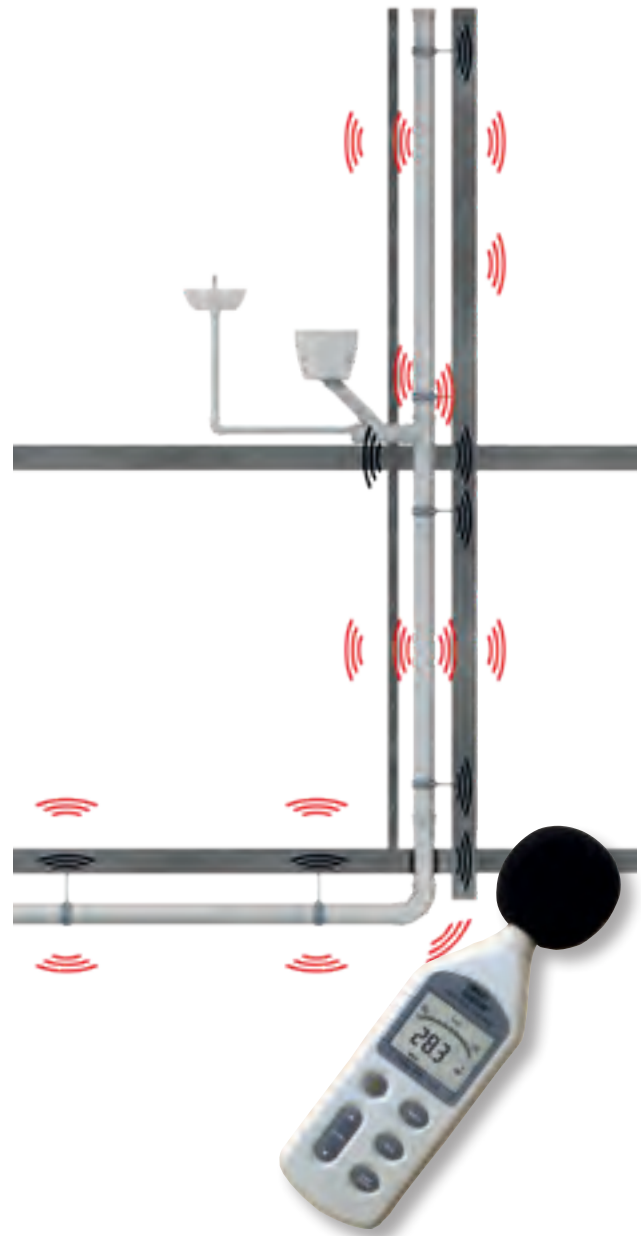
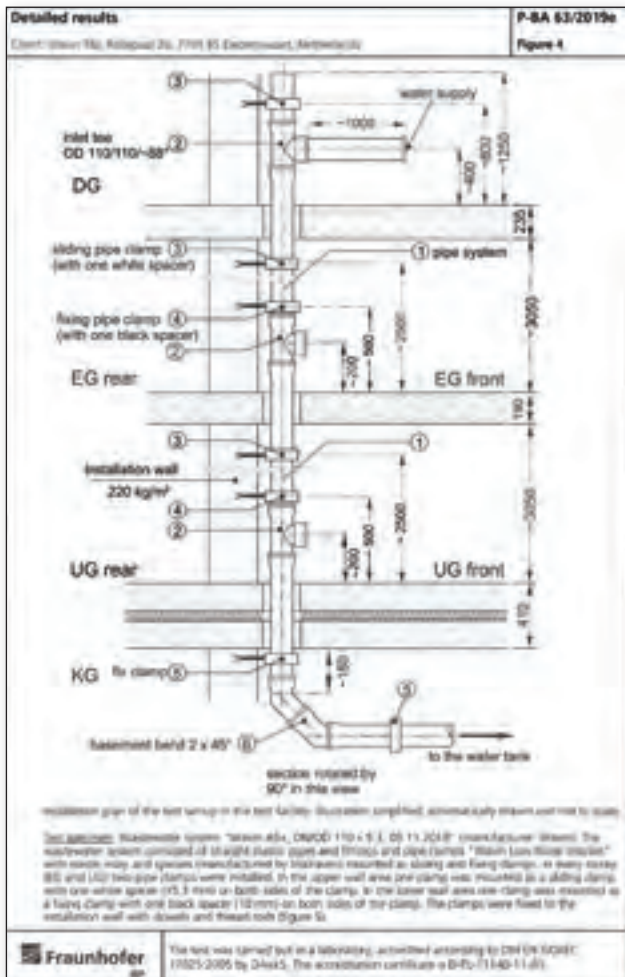

Fig. 3: FRAUNHOFER Test set up for determination of the installation sound level in the laboratory.

To actually determine real noise emission of the pipe system into a room requires a more dynamic test set up in which at least the following parameters can be modified.

- ⊙ Pipe system characteristics
- ⊙ Building design
- ⊙ Shaft characteristics
- ⊙ Suspended ceiling criteria
- ⊙ Structural characteristics of the building
- ⊙ Flow parameters
- ⊙ Installation requirements
- ⊙ Insulation requirements

3.2.1. Wavin SoundCheck tool

Calculating system acoustic just got easier

With noise regulations continuously being updated, calculating noise levels to ensure your design meets requirements can be a complex exercise. Wavin's online SoundCheck Tool is designed to relieve some of that stress.

Unique to Wavin, the SoundCheck Tool simulates system acoustics in a final installation and calculates noise levels based on individual parameters. In just four clearly defined and intuitive steps, you can get the answers you need to see if your design meets regulations.



3.3. Sound-insulating performance

The excellent sound protection properties of Wavin AS+ are primarily attributed to its thick-walled design as well as special molecular structure and the high density of ~1.9 g/cm³ of the material used to make the pipes and fittings. This property enables Wavin AS+ to absorb airborne sound as well as structureborne sound.

Studies conducted at the Fraunhofer Institut für Bauphysik (Fraunhofer Institute for Building Physics), Stuttgart, on Wavin AS+ attest to its excellent sound absorption properties.

Wavin low noise bracket	Volumetric flow rate*		Meets standard
	2 l/s	4 l/s	
DIN 4109 (public minimum legal requirement) specification 30dB(A)	14 dB(A)	19 dB(A)	✓
VDI 4100 sound insulation level II/III specification 27/24 dB(A)	11 dB(A)	16 dB(A)	✓
Installation noise level in rear basement (P-BA 63/2019)			
Wavin no noise bracket	Volumetric flow rate		Meets standard
	2 l/s	4 l/s	
DIN 4109 (public minimum legal requirement) specification 30dB(A)	<10 dB(A)	13 dB(A)	✓
VDI 4100 sound insulation level II/III specification 27/24 dB(A)	<10 dB(A)	10 dB(A)	✓
Installation noise level in rear basement (P-BA 64/2019)			

* Installation noise levels based on installation with Wavin system brackets.



With no noise

🕒 <10 dB(A) according to 63/2019

With low noise

🕒 14 dB(A) according to 64/2019

3.4. About Sound

Sound is a sensation felt, a perception of what takes place around us, caused by various compression waves which cross the eardrum and are captured and transformed by the brain; it is composed of different frequencies. The acuteness or intensity of the perception depends on the frequency and range.

Sound is a wave that is:

- ④ Elastic (it needs a medium to be propagated)
- ④ Longitudinal (perturbation takes place parallel to the direction of propagation).

To exist it requires:

- ④ A source (vibrating body)
- ④ An elastic propagation medium (air, water, etc.)

A sound is therefore a method of transmitting mechanical energy. To propagate, a sound needs a medium: any means, whether solid, liquid or gassy, like air, is able to transport sound, influencing its speed according to density.

Sound is propagated through the exchange of air-solid-air or solid-air vibrations (in the second case the solid is the source of the sound). With respect to soundproofing soil and waste systems, we need to think in two different directions: (1) the noise created in the pipes and transmitted by them and (2) noise which is transmitted by the walls or surrounding media.

Sound is measured with a phonometer, an instrument which filters noise and measures intensity at its different frequencies. It is expressed in decibels.

The decibel is the logarithm of the ratio between the measured sound pressure and a reference sound pressure, multiplied by ten.

dB = 10 log (P/Pa)

We need to remember that sound is an energy (just think of when you stand in front of the stereo speakers and you can “feel” the basses) but what we perceive is a processed sensation.

The human ear is sensitive to pressure in a NON LINEAR manner; therefore twice the pressure does not correspond to twice the sensation.

The doubling of acoustic power corresponds to an increase of 3 dB.

Every 10 dB increase is perceived by the human ear as twice as loud (10 cars are perceived as twice as loud as 1 car).

60 dB + 50 dB + 40 dB = 60.5 dB →
The highest dB is in a sum the most important

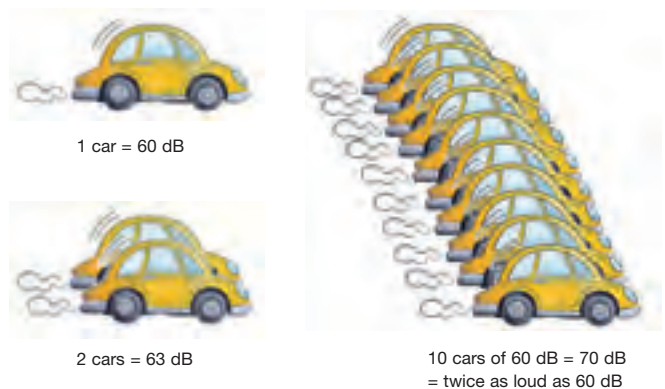

Sound intensity follows an inverse square law with distance from the source; doubling the distance from a noise source reduces its intensity by a factor of four, or 6 dB.

3.5. Noise

Noise can be described as unwanted sound. In relation to sound, noise is not necessarily random.

Acoustic noise can be anything from quiet but annoying to loud and harmful causing permanent irreversible hearing damage.



Based on the World Health Organization (WHO) guidelines, European countries have maximized the noise level (in houses, apartments, hospitals, elderly homes, hotels, etc.) during the night to:

$L_{A \max \text{ night}} = 30 \text{ to } 35 \text{ dB(A)}$.

Community noise (also called environmental noise, residential noise or domestic noise) is defined as noise emitted from all sources except noise at the industrial workplace.



Fig. 4: Example of community noise.

In the European Union about 40% of the population is exposed to road traffic noise with an equivalent sound pressure level exceeding 55 dB(A) daytime, and 20% are exposed to levels exceeding 65 dB(A). When all transportation noise is considered, more than half of all European Union citizens is estimated to live in zones that do not ensure acoustical comfort to residents. At night, more than 30% are exposed to equivalent sound pressure levels exceeding 55 dB(A), which are disturbing to sleep. Noise pollution is also severe in cities of developing countries.

In contrast to many other environmental problems, noise pollution continues to grow and it is accompanied by an increasing number of complaints from people exposed to the noise. The growth in noise pollution is unsustainable because it involves direct, as well as cumulative, adverse health effects.

For instance sleep disturbance: measurable effects of noise on sleep begin at sound levels of about 30 dB. However, the more intense the background noise, the more disturbing is its effect on sleep. Sensitive groups mainly include the elderly, shift workers, people with physical or mental disorders and other individuals who have difficulty sleeping.

Table 2 presents the WHO guideline values arranged according to specific environments and critical health effects. The guideline values consider all identified adverse health effects

Specific environment	Critical health effect(s)	L_{Aeq} (dB(A))	Time base (hours)	Leq,90 (dB)
Outdoor living area	Serious annoyance, daytime and evening	65	16	-
	Moderate annoyance, daytime and evening	70	16	-
Living, eating	Speech intelligibility & moderate annoyance, daytime & evening	55	16	-
Bedrooms	Sleep disturbance, night time	55	8	45
Outdoor bedrooms	Sleep disturbance, window open (outdoor noise)	45	8	35
Sleeping rooms & bedrooms, indoors	Speech intelligibility, disturbance of television reception, (strong communication)	55	during sleep	-
Practical bedrooms, indoor	Sleep disturbance	50	sleeping time	45
Sleeping, sleeping position	Adverse health effects	55	during sleep	-
	Sleep disturbance, night time	55	8	45
Hearing, ear and cochlea, indoors	Sleep disturbance, daytime and evening	55	16	-
	Hearing, impaired, noise, indoors	65	16	55
Industrial, commercial shopping and office areas, floors and outdoors	Hearing impairment	70	2+	115
Catered, hotels and restaurants, events	Hearing impairment (outdoor exposure)	100	4	115
Public addresses, indoors and outdoors	Hearing impairment	85	1	115
Musical and other sounds through headphones/earbuds	Hearing impairment (headset value)	85-95	1	115
Inquire sounds from TVs, DVDs and Blu-rays	Hearing impairment (noise)	-	-	145
	Hearing impairment (LAFmax)	-	-	100
Outdoor in parking and construction sites	Revelation of structure	85	-	-

- #1: As low as possible.
- #2: Peak sound pressure (not LAF, max) measured 100 mm from the ear.
- #3: Existing quiet outdoor areas should be preserved and the ratio of intruding noise to natural background sound should be kept low.
- #4: Under headphones, adapted to free-field values.

Table 1: Guideline values for community noise in specific environments (Source World Health Organization).

for the specific environment. An adverse effect of noise refers to any temporary or long-term impairment of physical, psychological or social functioning that is associated with noise exposure. Specific noise limits have been set for each health effect, using the lowest noise level that produces an adverse health effect (i.e. the critical health effect).

It is not enough to characterize the noise environment in terms of noise measures or indices based only on energy summation (e.g., LAeq), because different critical health effects require different descriptions.

It is equally important to display the maximum values of the noise fluctuations, preferably combined with a measure of the number of noise events. A separate characterization of night-time noise exposures is also necessary.

For indoor environments, reverberation time is also an important factor for things such as speech intelligibility. If the noise includes a large proportion of low-frequency components, still lower guideline values should be applied.

Supplementary to the guideline values given in Table 2, precautions should be taken for vulnerable groups and for noise of certain character (e.g. low-frequency components, low background noise).

3.5.1. Sources of noise in buildings

The noise generated by the building and its utilities may be classified as follows:

- ⦿ Noise due to filling operations
- ⦿ Noise generated by control equipment
- ⦿ Intake noise
- ⦿ Discharge noise
- ⦿ Noise due to impact or shock

Noise is generated by moving parts or by flowing media. Waste water discharge pipes are prone to vibration, particularly where water flows through downpipes, or is forced to change direction in joints and elbows (noise due to impact or shock). Experience shows that the greatest problems are typically caused by the transmission of structural noise, particularly in the area of pipe clamps and brackets or where pipe-work is run through walls or ceilings.

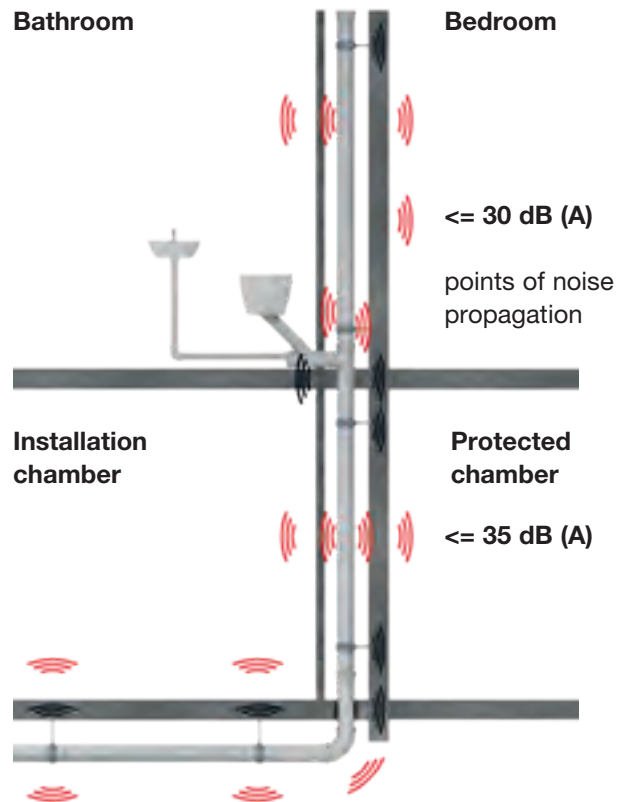

Fig. 5: Example of noise propagation during drainage.

The noise created from waste systems obviously depends greatly on the vertical piping. Here the falling water clashes against the wall of the pipes and fittings. The generated noise is transmitted directly to the pipes and indirectly through the ducts and installation walls. Therefore, the thickness and mass of the solid materials are of great importance, just like the fixing brackets and other elements which connect pipes to their supports.

3.5.2. How noise is measured

If we consider the “installation chamber” to be the room in which the pipes are installed (generally the bathroom), the room next door divided by the installation wall is called the “protected chamber”. The noises emitted are measured in the protected chamber according to EN 14366.

3.6. Acoustic requirements

Local ruling increasingly describe the maximum acceptable sound level inside the living area of a building. Subsequently such noise limitation will then have to be established in contracts between the contractor and the awarding authority. The following technical regulations contain relevant advice and suggestions, which require a contractual agreement to become binding.

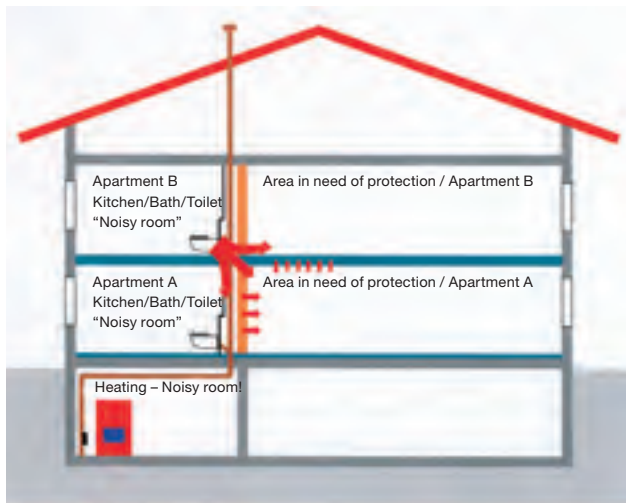

■ Shared floor/ceiling in residential apartment building > 410 kg/sq.m
 ■ Single-skin installation wall within domestic living quarters > 220 kg/sq.m

Fig. 6: Example of areas requiring protection.

DIN 4109 Supplement 2:

This supplement contains instructions relating to noise levels that lie 5 dB (A) below the values given in DIN 4109-1:20/6-07.

In accordance with DIN 4109 Supplement 2, increased levels of sound insulation can be arranged, by agreement, to a maximum of 25 dB (A) in other areas requiring noise protection.

VDI 4100

In addition to the requirements of DIN 4109, which was adopted as Noise Protection Level I (NPL I), this guideline contains characteristic values for two additional noise protection levels – NPL II and NPL III.

These two additional noise protection levels specify the arrangements for increased sound insulation.

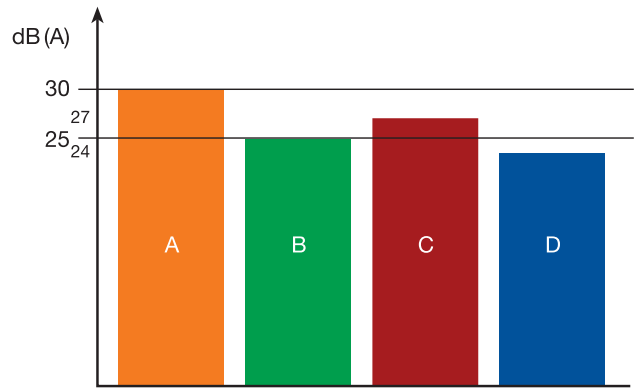

- A: DIN 4109 (minimum legal requirements)
- B: DIN 4109 Supplement 2
- C: VDI 4100 Noise Protection Level II
- D: VDI 4100 Noise Protection Level III

Fig. 7: Overview Noise Protection Standards and Guidelines.

3.7. Acoustic design

3.7.1. Advantageous layout

An important factor for the assurance of acoustic insulation is the design and implementation of an acoustically advantageous layout.

The following measures have proven to be of significant influence to the level of noise generated from the soil system inside the building:

- ⦿ Noise-sensitive areas should be kept away, as far as possible, from sources of noise
- ⦿ Non-sensitive areas should, wherever possible, be used as “buffer zones”
- ⦿ Noise-sensitive areas should not be positioned in the direct vicinity of bathrooms, toilets or stairwells
- ⦿ Potential sources of noise should be “bundled together” in the same area

The comparison between the two examples of layout shown above demonstrates how the acoustically advantageous layout in the second example contributes to a clear reduction in the acoustic pressure of the systems in the room which demands acoustic insulation.

However, even using highly efficient low-noise waste systems like Wavin AS+, one always has to seek for the best possible acoustic decoupling. This goes for the whole drainage system and its points of contact with the building (collars, crossings through walls and floors, plaster residues between the pipe and the building, etc...).

In designing piping, moreover, we need to avoid positioning waste pipes in the partition walls between apartments. Special noise-reduction measures also need to be adopted when fixing drain pipes to the partition walls between apartments. Protect the pipes from the propagation of intrinsic noise.

Apartment A

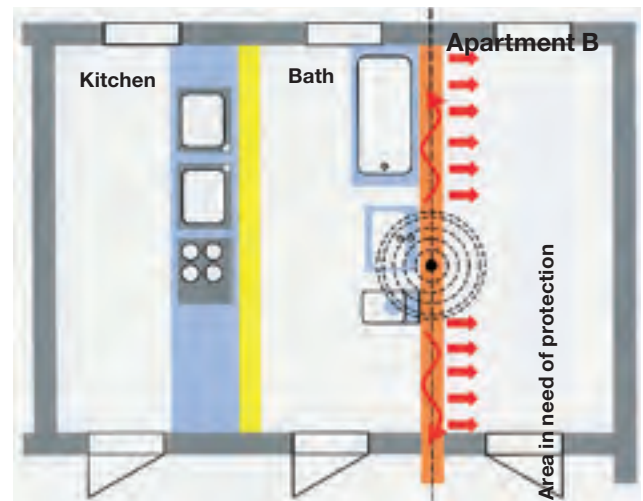

Apartment A

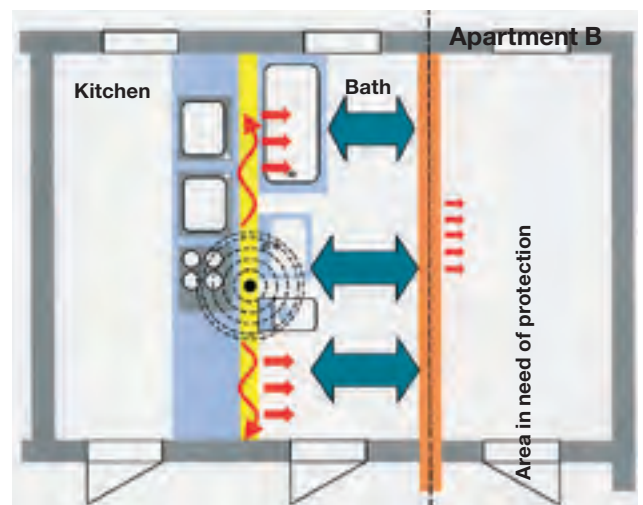

■ Room dividing wall ■ Installation in own living room wall

The comparison of the floor plans above demonstrates how good acoustic design in the lower building example can significantly reduce the noise levels to which areas requiring noise protection are exposed.

Fig. 8: Examples of good acoustic practice in building design.

3.7.2 Acoustic plumbing design

Wavin AS+ can significantly reduce noise levels when compared with other piping systems. However, when installing high-performance sound-insulating waste water piping systems it is still necessary to consider how effectively the system can be sound-isolated. This applies to the waste water discharge system as a whole, including its points of contact with the building structure (pipe brackets and clamps, the running of pipework through walls and ceilings, mortar droppings between pipes and wall surfaces, etc.).

When planning pipe installation, waste water discharge pipes should not be allowed to run inside the walls separating living areas. The attachment of waste water discharge pipes to partition walls in living areas should only be carried out under application of special noise protection measures. DIN 4109 requires that single-skin walls to which, or in which, water installations or equipment (i.e. waste water pipes) are to be attached must have an area-related mass of at least 220 kg/sq.m. Walls having an area-related mass of less than 220 kg/sq.m may only be used where prior testing has demonstrated that the walls exhibit acceptable properties with respect to the transmission of noise.

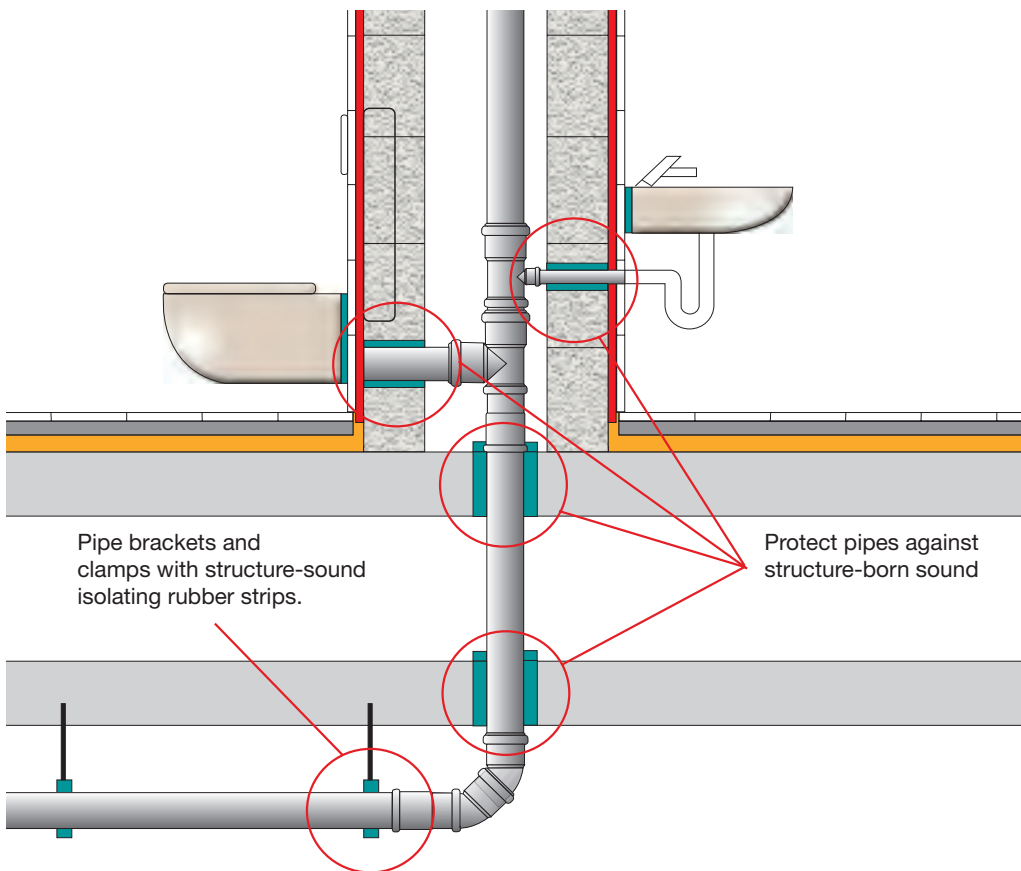

Fig. 9: Sound insulation of waste water systems.

4. Design of the waste water system

4.1. Installation and layout principles for waste water drainage systems

The technical aspects of waste water drainage systems have been regulated in Europe for some time by an extensive set of standards established in the course of ongoing European harmonisation, started in 2001 with DIN EN 12056 (“Gravity drainage systems inside buildings”).

This European drainage system standard consists of five parts

Part 1: General and performance requirements

Part 2: Sanitary pipework, layout and calculation

Part 3: Roof drainage, layout and calculation

Part 4: Waste water systems, layout and calculation

Part 5: Installation and testing, instructions for operation, maintenance and user

May 2008 saw the publication of the updated version of DIN 1986-100 “Drainage systems for buildings and provisions for private ground [...] in relation to DIN EN 752 and DIN EN 12056”.

This standard contains additional technical requirements for drainage systems, based on the earlier German standard DIN 1986, Parts 1+2, which were not incorporated into the DIN EN 12056 set of European standards.

The current version of the standard (from 2016) has been reorganised into key points for better readability, including, for example:

- ⦿ Basic requirements for the design and completion of waste water and rainfall drainage systems
- ⦿ The installation of pipes inside and outside buildings
- ⦿ Requirements concerning the quality and quantity of waste water
- ⦿ Backflow prevention
- ⦿ Sizing of waste water and rainfall drainage systems

DIN 1986-100 is therefore an extension of European waste water regulations for application in Germany, with uniform technical provisions for the design, construction, operation and maintenance of drainage systems used for the disposal of waste water in buildings and on private property.

For the sake of completeness, we also include other parts of the above-mentioned DIN 1986.

Part 3:
Specifications for service and maintenance

Part 4:
Fields of application of sewage pipes

Part 30:
Maintenance of waste water drainage systems

4.2. List of definitions according to DIN EN 12056

Waste water drainage system

Structural system for the collection, drainage, disposal and treatment of waste water in buildings and on private property.

Underground collector pipe

A non-accessible pipe, installed below ground or in the foundations, for the disposal of waste water (normally via the connecting sewer)

Collecting pipe

Horizontally installed pipe for the collection of waste water from downpipes and connected lines not buried below ground or installed in foundations

Downpipe

Perpendicular pipe for the collection of waste water from individual and collective inlets. It directs the flow of waste water to a collecting pipe or underground and collector pipe

Collecting connection pipe

Pipe designed to collect waste water from various single connection pipes and direct it to a downstream pipe

Single connection pipe

Pipe from a sink drain or other drainage outlet, designed to direct waste water to a downstream pipe

Bypass pipe

Pipeline for connection pipes in the retention area of a downpipe offset or in the transition between a downpipe and a collecting pipe or underground and collector pipe

Discharge unit (DU)

The average discharge rate of a sanitary appliance expressed in litres per second (l/s)

Frequency factor

Variable to take into account the frequency of use of sanitary appliance (dimensionless)

Waste water flow rate (Q_{ww})

Total design flow rate from sanitary appliances in a drainage system or in a part of a drainage system in litres per second (l/s)

Continuous flow rate (Q_c)

Flow rate of all continuous flows, e.g. cooling water, etc. in litres per second (l/s)

Pumped water flow rate (Q_p)

Discharge rate of waste water pumps in litres per second (l/s)

Total flow rate (Q_{tot})

The total flow rate is the sum of the waste water flow rate (Q_{ww}) and continuous flow rate (Q_c) and pumped water flow rate (Q_p) in litres per second (l/s)

Hydraulic capacity (Q_{max})

Maximum flow rate of air through a ventilating pipe or air admittance valve, measured at 250 Pascal (Pa) pressure drop, in litres per second (l/s)

Types of system

The many types of drainage system that currently exist are a result of widely ranging areas of application for sanitary equipment in different countries and the variety of technical procedures and regulations that govern such systems.

DIN EN 12056 classifies European waste water drainage systems into four types.

System I

Single downpipes with partly-filled connection pipes.

Sanitary drainage sources are joined to partly-filled connection pipes. These partly-filled connection pipes are designed for a filling factor (h/d) of 0.5 (50%), and are in turn connected to an individual waste water downpipe.

System II

Single downpipes with partly-filled connection pipes.

Sanitary drainage sources are joined to connection pipes of reduced size. These connection pipes are designed for a filling factor (h/d) of 0.7 (70%), and are in turn connected to an individual waste water downpipe. This configuration is used mainly in Scandinavian countries. It is not used in Germany.

System III

Single downpipe system with fully-filled connection pipes.

Sanitary drainage sources, which are linked via connection pipes and operated in a fully-filled state. These filled connection pipes have a filling factor (h/d) of 1.0 (100%). Each individual connection pipe is separately connected to the downpipe. System III is the preferred configuration in English-speaking countries. It is not used in Germany.

System IV

System with separate waste water downpipes.

Configurations corresponding to systems I, II and III can also be divided into a waste water downpipe that collects waste from toilets and urinals and a waste water downpipe designed to collect waste water from all other drainage sources. This configuration is mainly used in France. Its use in Germany is only possible to a limited extent.



System I + II.



System III.



System IV.

Fig. 10: Waste water drainage systems in Europe.

4.3. Functional requirements

The dimensional specifications of waste water standards are based on various requirements:

- ⦿ The loss of trap water resulting from the flow of water must not reduce the total level of the water seal by more than 25 mm in height.
- ⦿ The trap water must not be sucked out by a vacuum or expelled by excess pressure.
- ⦿ The nominal dimensions of waste water and mixed-water systems must not exceed those specified in DIN 1986-100.
- ⦿ The waste water pipeline must be self-cleaning.

The following sizing method applies to all gravity waste water drainage systems designed to dispose of domestic waste water. The layouts of industrial and commercial waste water drainage systems used in such places as swimming pools or factory buildings must be designed individually. Performance figures are based on the minimum internal diameters specified in the table in DIN EN 12056-2.

Please note that the product standards applied to pipes and fittings used in Germany are based on outside diameters, which might lead to certain deviations with respect to the tables in DIN EN 12056.

Nominal diameter DN	Minimum internal diameter Di (mm)
50	44
70	68
90	79
100	96
125	113
150	146
200	184

Nominal diameter DN	Minimum internal diameter Di (mm)
50	44
70	68
90	80,8
100	99,4
125	114,4
150	148,8
200	188

Nominal diameter (DN) with corresponding internal diameter $D_{i_{min}}$ as per Table 1, DIN 12056-2 (extract).

Nominal diameter and diameter used by Wavin AS+.

Minimum fall

Compliance with the required minimum fall is vital for the proper drainage of waste water. Waste water standards specify different minimum falls, depending on the piping area concerned

Area of piping	Minimum fall	Standard/section
Unventilated connection pipes	1%	DIN EN 12056-2, Table 5 DIN 1986-100, Section 14.1.3.3
Ventilated connection pipes	0.5%	DIN EN 12056-2, Table 8
Underground and collector pipe and collecting pipes		DIN 1986-100, Section 14.1.1+14.1.5
a) Waste water inside the building	0.5%	DIN 1986-100, Section 14.2.7.3
b) Waste water outside the building	1: DN	

Tabel 2: Minimum fall for waste water pipes in different piping areas.



Fig. 11: Minimum fall for waste water pipes, example.

A	Unventilated connection pipe	min. 1.0%
B	Ventilated connection pipe	min. 0.5%
C	Collecting pipe wastewater > DN 100	min. 0.5%
	Collecting pipe wastewater DN 90	min. 1.5%
D	Collecting pipe rainwater	1:DIN

Basis of calculations

The hydraulic calculations for a waste water system begin at the starting point (e.g. a sink, toilet or shower, etc.) and cover the rest of the piping, the layout of which depends on the items included.

- ⦿ Single connection pipe
- ⦿ Collecting connection pipe
- ⦿ Downpipe
- ⦿ Collecting pipe
- ⦿ Underground and collector pipe

Please refer to the following pages of the manual for further details of the areas covered by the waste water drainage pipes. The sum total quantities of waste water to be disposed of are normally based on various parameters.

The formula for calculating domestic waste water in accordance with DIN 12056 is as follows:

Basis of calculation DIN EN 12056:

$$Q_{\text{WW}} = K \cdot \sqrt{\sum DU}$$

$$Q_{\text{tot}} = Q_{\text{WW}} + Q_{\text{C}} + Q_{\text{P}}$$

Q_{WW} = Wastewater discharge
[flow rate of waste water]

Q_{tot} = Total wastewater discharge [l/s]
[flow rate, total]

Q_{C} = Continuous discharge [l/s]
[flow rate, constant]

Q_{P} = Pump flow rate
[flow of discharge from pumps]

DU = Design unit
[design unit]

As in the equation Q_{ww} , this takes into account the discharge coefficient K and the discharge unit DU.

Frequency factor K describes the frequency of use of the sanitary drainage sources concerned, along with its simultaneity. Frequency factor K is not expressed in dimensional terms.

Type of building	K
Non-regular usage (e.g. in residential properties, boarding houses and offices)	0.5
Regular usage (e.g. in hospitals, schools, restaurants and hotels) and/or showers)	0.7
Frequent usage (e.g. in public toilets)	1.0
Special usage (e.g. laboratories)	1.2

Table 3: Typical frequency factor K as per DIN EN 12056 - 2.

The discharge unit DU is described in terms of the expected amount of waste water for a given drainage source. 1 DU = 1 l/s.

Types of pipes and sections

Single connection pipes

The term “single connection pipe” refers to a pipe that runs from a drainage source (connection point) to a downpipe, collection pipe or underground and collector pipe. Multiple single connection pipes supply waste water to the collection pipes that run to the downpipe, collection pipe or underground and collector pipe concerned. A distinction is made between unventilated and ventilated single connection pipes. These are subject to allowable waste water discharge with respect to:

- ⊕ Maximum length of pipe
- ⊕ Maximum number of changes of direction (bends, etc.)
- ⊕ Maximum height difference along the length of the pipe
- ⊕ Minimum fall

Application boundaries for unventilated single connection pipe conforming to DIN 12026-2, System I

Max. length of pipe (l)	4.0 m
Maximum number of changes of direction (90°)	3 x*
Maximum height difference	1.0 m
Minimum fall	1%

*Not including connection bends

Table 4: Application boundaries for unventilated single connection pipes conforming to DIN EN 12056-2, Table 5.

If the system cannot fulfil the specifications of the above-mentioned table, the connecting pipe must be ventilated. The allowable limitations in the table for ventilated single connection pipes will then apply.

Application boundaries for ventilated single connection pipes conforming to DIN 12056-2, System I

Max. length of pipe (l)	10.0 m
Maximum number of changes of direction (90°)	No limit
Maximum height difference	3.0 m
Minimum fall	0.5%

Table 5: Application boundaries for ventilated single connection pipes conforming to DIN EN 12056-2, Table 5.

Once it has been established whether an unventilated or ventilated single connection pipe is required, the dimensions are established in accordance with the following table and depending on the drainage source concerned.

Drainage source	Discharge unit (DU) Single connection pipe (DN)	Dimensions,
Washbasin, bidet	0.5	40
Shower without plug	0.6	50
Shower with plug	0.8	50
Individual urinal with flushing cistern	0.8	50
Urinal with pressurised flushing	0.5	50
Stand-type urinal	0.2	50
Non-flushing urinal	0.1	50
Bathtub	0.8	50
Kitchen sink and dishwasher*	0.8	50
Dishwasher	0.8	50
Washing machine (up to 6 kg)	0.8	50
Washing machine (up to 12 kg)	1.5	56/60
WC with 4.0/4.5 l flushing cistern	1.8	80/90
WC with 6.0l cistern/pressurised flushing	2.0	80-100
WC with 7.5l cistern/pressurised flushing	2.0	**
WC with 9.0l cistern/pressurised flushing	2.5	100
Floor drain, DN 50	0.8	50
Floor drain, DN 70	1.5	70
Floor drain, DN 100	2.0	100

* with shared sink drain

** not subject to this standard's scope of application

Table 6: Discharge units (DU) as per DIN 1986-100, Table 6.

Collecting connection pipes

Collecting connection pipes collect waste water from various single connection pipes and carry it to the next pipe section (e.g. a downpipe). Here, too, the load-bearing limitations apply. Ventilated collecting connection pipes therefore deliver considerably better performance than unventilated ones.

The layout dimensions of collecting connection pipes are established by adding together the discharge units (DU) of the corresponding section of collecting connection pipe ($\sum DU$), using tables 5+6, subject to the corresponding frequency factor K.

The following also applies:

- ⦿ Minimum fall $J = 1 \text{ cm/m}$.
- ⦿ The sum total of discharge units must not exceed $\sum DU = 16$.
- ⦿ The limitations for unventilated/ventilated collecting connection pipes must be observed.
- ⦿ A distinction must likewise be made between unventilated and ventilated collecting connection pipes when carrying out dimensional calculations.
- ⦿ Dimensional calculations are based on the Prandtl-Colebrook formula.

Application boundaries for unventilated collecting connection pipes

Nominal diameter DN	Di mm	Max. length of pipe m direction (90°)	Max. number of changes of M	Max.height difference	Minimum fall %
50	44	4.0	3	1.0	1
56	49	4.0	3	1.0	1
70	68	4.0	3	1.0	1
80	75	10.0	3	1.0	1
90	79	10.0	3	1.0	1
100	96	10.0	3	1.0	1

Table 7: Application boundaries for unventilated collecting connection pipes conforming to DIN 1986-100.

Application boundaries for ventilated collecting connection pipes

Max. length of pipe m	Max. number of changes of direction (90°)	Max. height difference M	Minimum fall %
10.0	No limit	3.0	0.5

Table 8: Application boundaries for ventilated collecting connection pipes conforming to DIN EN 12056-2, Table 8.

Sizing of unventilated collecting connection pipes

K=0.5 ΣDU	K=0.7 ΣDU	K=1.0 ΣDU	DN	Di (mm)
1.0	1.0	0.8	50	44
2.0	2.9	1.0	56/60	49/56
9.0	4.6	2.2	70*	68
13.0**	8.0	4.0	80	75
13.0**	10.0	5.0	90	79
16.0	12.0	6.4	100	96

Table 9: Sizing of unventilated collecting connection pipes in accordance with Prandtl-Colebrook.

Sizing of ventilated collecting connection pipes

K=0.5 ΣDU	K=0.7 ΣDU	K=1.0 ΣDU	DN	Di (mm)
3.0	2.0	0.8	50	44
5.0	4.6	1.0	56/60	49/56
13.0	10.0	2.2	70*	68
16.0	13.0	4.0	80	75
20.0	16.0	5.0	90	79
25.0	20.0	6.4	100	96

* not applicable to toilets.

Table 10: Sizing of ventilated collecting connection pipes in accordance with Prandtl-Colebrook.

Downpipes

Downpipes are vertical pipes that run down through the floors of a building and are ventilated at roof level. Downpipes should be as perpendicular as possible. Single and collecting connection pipes are connected via branches. The location of the branches should be given special attention during the planning and layout stage, as they have a direct impact on the sizing of the downpipe.

Proper matching of such items as branch pipes equipped with internal radius (swept) running into the downpipe can favour the hydraulics of the system, leading to the use of reduced dimensions.

Calculation

The waste water runoff is sized using the following equation:

$$Q_{WW} = K \cdot \sqrt{\sum DU}$$

The pipe diameters of ventilated downpipes conforming to DIN 12056-2, Table 10 are determined using waste water discharge calculation Q.

Allowable waste water discharge in primary-ventilated downpipes

Primary-ventilated downpipe DN	Q _{max} (l/s)	
	Standard branch pipe	Branch pipe with internal radius (swept)
60	0.5	0.7
70	1.5	2.0
80*	2.0	2.6
90	2.7	3.5
100**	4.0	5.2
125	5.8	7.6
150	9.85	12.4
200	16.0	2.0

* Minimum nominal diameter for toilets with flushing volumes of 4-6 l

** Minimum nominal diameter for toilets with flushing volumes of > 6 l

Table 11: Allowable waste water discharge in primary-ventilated downpipes conforming to DIN 12056-2.

Downpipes with secondary ventilation conforming to DIN EN 12056-2 must be sized separately.

Configurations with secondary ventilation are used, for example, in waste water systems subjected to high loads.

Allowable waste water discharge in secondary-ventilated downpipes

Primary-ventilated downpipe	Secondary ventilation DN	Q _{max} (l/s)	
		Standard branch pipe DN	Branch pipe with internal radius (swept)
60	50	0.7	0.9
70	50	2.0	2.6
80*	50	2.6	3.4
90	50	3.5	4.6
100**	50	5.6	7.3
125	70	12.4	10.0
150	80	14.1	18.3
200	100	21.0	27.3

* Minimum nominal diameter for toilets with flushing volumes of 4-6 l

** Minimum nominal diameter for toilets with flushing volumes of > 6 l

Table 12 : Allowable waste water discharge in secondary-ventilated downpipes conforming to DIN 12056-2.

Kitchen downpipes

A maximum of four kitchens may be connected to a DN 70 downpipe. If more than four kitchens are connected, waste water discharge calculation Q_{ww} must be verified and the dimensions of the downpipe increased.

Layout

Waste water downpipes must be installed:

- ④ without any change of nominal diameter
- ④ as straight as possible via the individual floors and up to the roof

Connections measuring \leq DN 70 must be used with branches of 87.5° .

Neighbouring residential buildings may only be connected to a shared waste water pipe under certain conditions.

1. Conformity with required fire-prevention measures
2. Conformity with noise-protection requirements

Corresponding installation measures are also required for waste water downpipes that change direction, due to the resulting pressure ratios.

Offsets requiring \leq 1 metre and $\leq 45^\circ$ may be used. Larger offsets require two 45° bends and a 250 mm coupler. Wavin offers ready-made solutions for this purpose in the form of extended bends, for example.

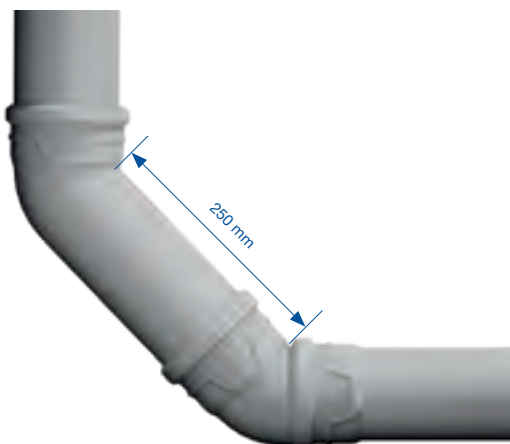

Fig. 12: Wavin AS+ long bend.

Different rules are to be observed, depending on the height of the downpipe, when directing downpipes into a collecting pipe. Failure to observe these rules may lead to build-ups of pressure or undesired vacuums in the upstream/downstream section on either side of the change of direction.

This can in turn cause sink traps to be sucked empty, leading to bad smells, or to seepage of waste water into the affected area.

DIN 1986-100 therefore makes the following distinctions:

Downpipes of up to 10 m in height

On downpipes of less than 10 m in length, the change of direction in the horizontal pipe may be carried out using an 87.5° bend. However, a technically more ideal solution, from a hydraulic and noise-prevention point of view, is to base the change of direction on two 45° bends.

Downpipes of > 10 m to 22 m in height

In the case of downpipe offsets >2 m, the following areas should be kept free of drainage connection points:

1. Min. 2m above the bend on the inlet side.
2. Min. 1m downstream of the outflow bend and 1 m upstream of the outflow bend of an offset running to a horizontal pipe.

This does not apply to downpipe offsets with a change of direction of up to 45° .

In the case of a downpipe offset, the bends on the inlet and outflow side should be fitted with a 250 mm extended bend.



Fig. 13: Downpipe offset > 2 m with pipe sections free of connection points.

A bypass pipe should be used for downpipe offsets < 2 m.

The bypass pipe should be connected at least 2 m above the inlet bend and 1 m below it. The bypass pipe should measure no more than DN 100 (preferably less), in accordance with the dimensions of the downpipe.

The 250 mm coupler can be omitted if a bypass pipe is installed.

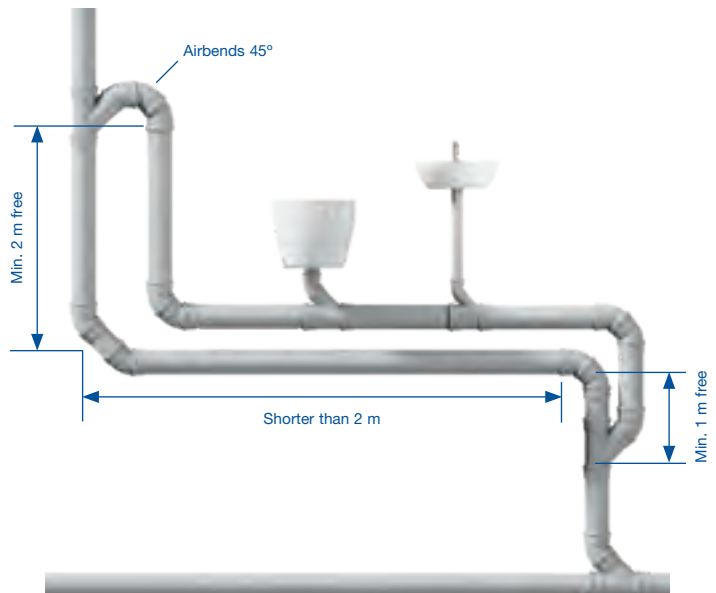

Fig. 14: Downpipe offset < 2 m, with bypass pipe and piping areas without connection points.

Downpipes > 22 m

In the case of downpipes measuring more than 22 m in length, the downpipe offsets and the downpipe coupler should be connected to the horizontal pipe using bypass pipes.

If the offset is > 2 m, the method of installation shown in Fig.13 must be used. Otherwise the configuration shown below in Fig. 15 is applied. In these cases, either an extended bend or a 250 mm coupler must always be installed.

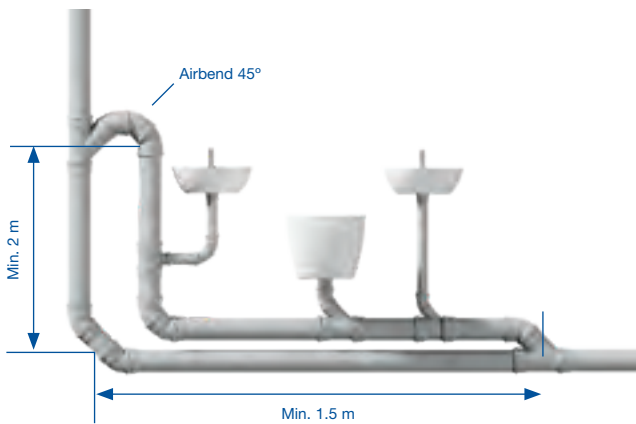

Fig. 15: Downpipe offset > 2 m with bypass pipe, or bypass pipe for transitioning from a downpipe to a collecting pipe.

Multiple offset downpipes

If multiple offset downpipes are required (as in the case of terraced houses, for example), they must be equipped with direct or indirect secondary ventilation.

Drainage sources should be connected to horizontal pipes wherever possible.

Please refer to DIN EN 12056, Part 2, for further information on waste water drainage systems with secondary ventilation.

Connecting collecting pipes to the downpipe

The rules for the proper hydraulic connection of collecting pipes to downpipes are established in DIN 1986-10. In the worst of cases, failure to observe these rules can lead to so-called inward seepage.

Connection pipes for toilets, bathtubs and showers, and also bathroom inlets, should therefore be connected to the downpipe in such a way that dimension h is \geq the DN of the connecting pipe (where h = the difference in height between the water level in the sink trap and the bottom of the connecting pipe at the downpipe branch).

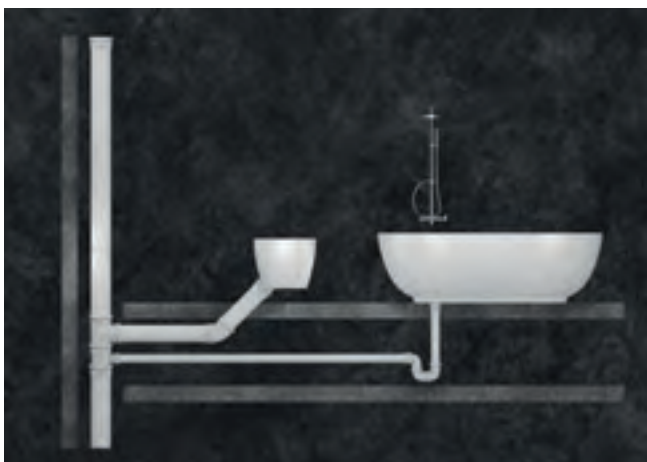

Fig. 16: Correct entry into a downpipe.

Backflow

Connection pipes installed next to or opposite each other must be protected to prevent backflow. DIN 1986-10 contains corresponding suggestions for a hydraulically correct connection to a downpipe, as shown in the following illustrations.

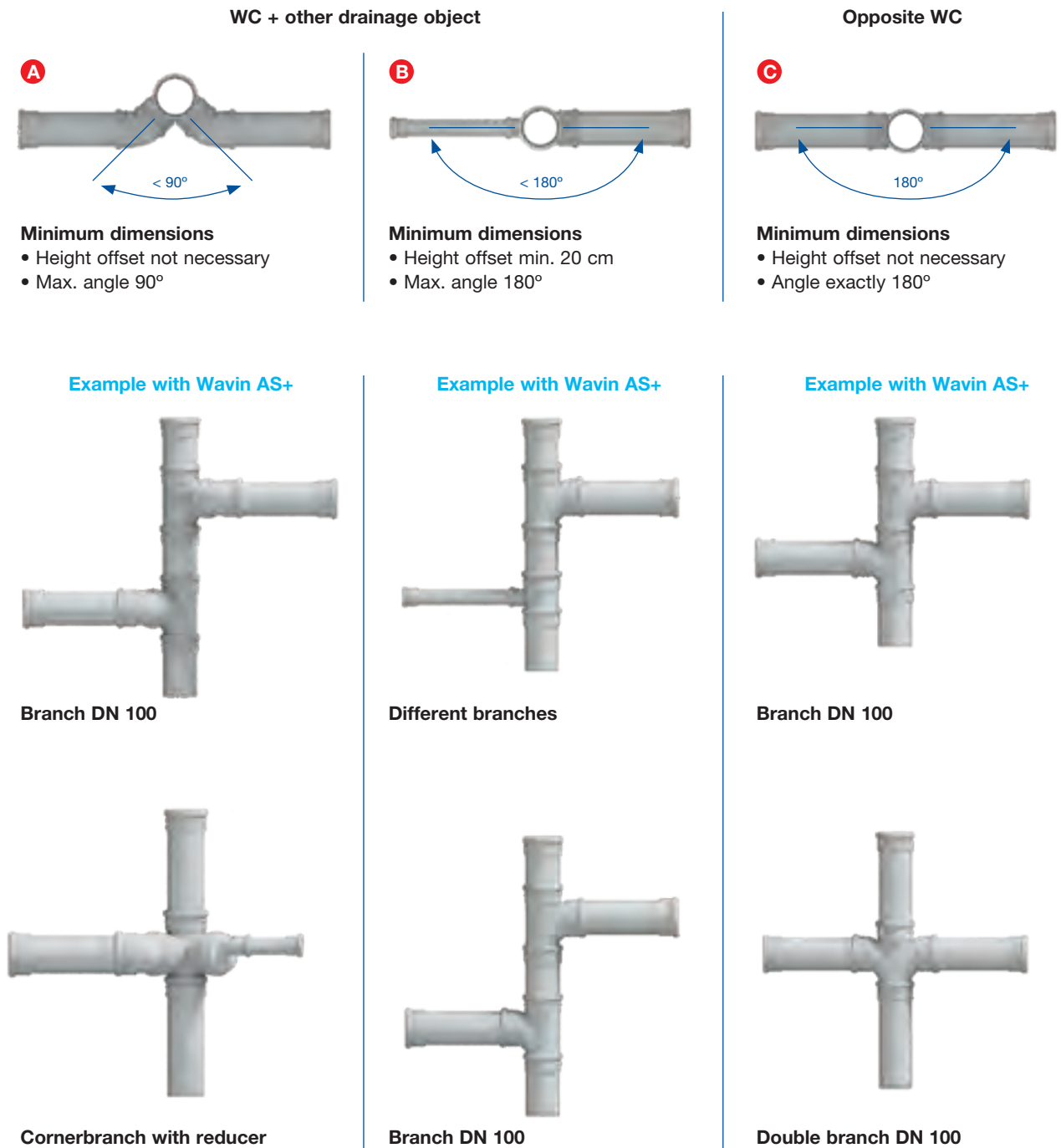

Fig. 17: Example of hydraulically correct connection to a downpipe.

Collecting pipes

Collecting pipes are defined as any type of installed pipe designed to take up waste water from single or collecting collection pipes and downpipes. Collecting pipes are preferable to underground and collecting pipes for installation inside buildings, as they are easier to inspect, clean and maintain.

Calculation

Hydraulic specifications

- ④ Filling factor $h/d_i = 0.5$
- ④ Minimum fall $J = 0.5 \text{ cm/m}$
- ④ Minimum flow rate 0.5 m/s
- ④ Upstream inward volume flow from a waste water pump station, filling factor $h/d_i = 0.7$

Collecting pipes are subject to the equation:

$$Q_{\text{tot}} = Q_{\text{ww}} + Q_{\text{c}} + Q_{\text{p}}$$

Q_{tot} describes the total flow of waste water from the drainage system.

The total waste water discharge (Q_{tot}) includes both waste water from sanitary drainage points (e.g. showers, toilets and wash basins, etc.) and the amount of water from “continuous” drainage points (Q_{c}), such as condensate from air conditioning systems or drainage from swimming pools. The total waste water discharge also includes volume flows from pump stations (Q_{p}).

Sizing of the collecting pipe should take into account both the calculated total discharge of drainage water and the maximum discharge unit (DU). This is clarified by the example shown below.

Sanitary drainage points connected to the collecting pipe.

- 1 x wash basin (DU = 0.5)
- 1 x WC with a 4.5-litre cistern (DU = 1.8)

Waste water discharge Q_{ww} is calculated as follows:

$$Q_{\text{ww}} = 0.5 \times \sqrt{(0.5+1.8)} = 0.76 \text{ l/s}$$

As the discharge unit for the WC (1.8 l/s) is greater than the calculated waste water discharge of 0.76 l/s, the collecting pipe should be configured on the basis of 1.8 l/s.

Note

If total waste water discharge Q_{tot} is less than 2.0 l/s, the collecting pipe can be sized using Table 10 of this manual (“Sizing of secondary-ventilated collecting pipes”). If the total waste water discharge is more than 2.0 l/s, sizing should be based on Table 10.

Underground and collector pipes

These are usually directly connected to downpipes or to drainage sources installed in the basement of the building. They are buried under the floor of the building or installed in its foundations.

Collecting pipes should be chosen in preference to underground and collector pipes for installation inside buildings.

This does not apply to buildings without a basement. In these cases, the underground and collector pipes leading out of the building should be kept as short and as straight as possible. Underground and collector pipes with a minimum nominal diameter of DN 80 (Wavin AS+ = DN 90) may be connected to the nearest transfer shaft outside the building if hydraulic calculations permit.

If toilets with water-saving measures (flushing volumes of 4 to 4.5 l/s) are in use, check in each case to ensure that the self-cleaning performance of pipes with nominal diameters of 100 or more is ensured.

Examples of corresponding criteria include:

- ④ Nominal diameter of the collecting pipe and underground and collector pipe
- ④ Fall
- ④ Number and type of connected drainage sources
- ④ Simultaneity of waste water drainage

Bends measuring $\leq 45^\circ$ must be used for changes of direction in underground and collector pipes or collecting pipes. Branches must be connected to horizontal pipes at an angle of $\leq 45^\circ$.

Double branches must not be used with horizontal pipes. Changes of direction in horizontal pipes in open-shaft and enclosed-shaft configuration must likewise be carried out at an angle of $\leq 45^\circ$.

Note

Reducers/extensions of underground and collector pipes should be level.

Underground collector pipes

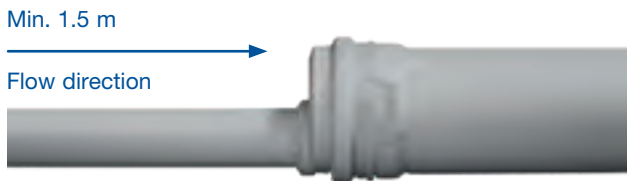

Fig. 18: Underground collector pipes.

For collector pipes

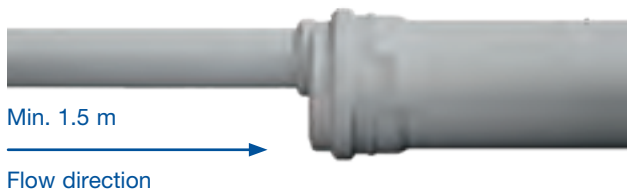

Fig. 19: For collector pipes.

Calculation

Hydraulic criteria for the sizing of underground and collector pipes

- ⦿ Filling factor $h/d_i = 0.5$ inside buildings
- ⦿ Filling factor $h/d_i = 0.7$ outside buildings
- ⦿ Filling factor $h/d_i = 1.0$ upstream of volume flow inlets running from a waste water pump station outside the building upstream of a drain shaft with open flow
- ⦿ Filling factor $h/d_i = 1.0$ in the case of mixed-water pipes measuring at least DN 150, upstream of a drain shaft with open flow

- ⦿ Minimum fall $J = 0.5$ cm/m inside buildings
- ⦿ Minimum fall $J = 1$: DN outside buildings
- ⦿ Minimum flow rate of 0.5 m/s inside buildings
- ⦿ Minimum flow rate of 0.7-2.5 m/s outside buildings

If plans and calculations contain no prior definition of pipe material, nominal diameters and usage can be based on the calculation tables in DIN 1986-100 (Annex A, Tables A.3 to A.5).

Calculated drainage performance is based on the smallest possible internal diameter, in accordance with the nominal size given in DIN EN 12056-3, 2001-01, Table 1.

If the material is known (e.g. Wavin AS+), sizing can also be performed based on the actual internal diameter.

The tables referred to are reproduced on the following pages of this waste water manual.

Sizing tables for underground and collector pipes

The sizing tables are reproduced on the following pages. Please note that a distinction is made between the tables conforming to DIN 1986-100, Annex A, and the tables corresponding to Wavin AS+. The tables are further differentiated by the maximum filling factor h/d_i of 0.5, 0.7 or 1.0.

Gradient J cm/m	DN 70 d _i =68		DN 80 d _i =75		DN 90 di=79		DN 100 di=96		DN 125 di=113		DN 150 di=146		DN 200 di=184		DN 225 di=207		DN 250 di=230		DN 300 di=290		
	Q l/s	v m/s	Q l/s	v m/s	Q l/s	v m/s	Q l/s	v m/s	Q l/s	v m/s	Q l/s	v m/s	Q l/s	v m/s	Q l/s	v m/s	Q l/s	v m/s	Q l/s	v m/s	
0,20														6,3	0,5	8,6	0,5	11,4	0,5	21,0	0,6
0,30												4,2	0,5	7,7	0,6	10,5	0,6	14,0	0,7	25,8	0,8
0,40									2,4	0,5	4,8	0,6	8,9	0,7	12,2	0,7	16,2	0,8	29,9	0,9	
0,50							1,8	0,5	2,7	0,5	5,4	0,6	10,0	0,8	13,7	0,8	18,1	0,9	33,4	1,0	
0,60					1,1	0,5	1,9	0,5	3,0	0,6	5,9	0,7	11,0	0,8	15,0	0,9	19,8	1,0	36,7	1,1	
0,70	0,8	0,5	1,1	0,5	1,2	0,5	2,1	0,6	3,2	0,6	6,4	0,8	11,8	0,9	16,2	1,0	21,4	1,0	39,6	1,2	
0,80	0,9	0,5	1,1	0,5	1,3	0,5	2,2	0,6	3,5	0,7	6,8	0,8	12,7	1,0	17,3	1,0	22,9	1,1	42,4	1,3	
0,90	0,9	0,5	1,2	0,6	1,4	0,6	2,4	0,7	3,7	0,7	7,3	0,9	13,4	1,0	18,4	1,1	24,3	1,2	45,0	1,4	
1,00	1,0	0,5	1,3	0,6	1,5	0,6	2,5	0,7	3,9	0,8	7,7	0,9	14,2	1,1	19,4	1,2	25,7	1,2	47,4	1,4	
1,10	1,0	0,6	1,4	0,6	1,6	0,6	2,6	0,7	4,1	0,8	8,0	1,0	14,9	1,1	20,4	1,2	26,9	1,3	49,8	1,5	
1,20	1,1	0,6	1,4	0,6	1,6	0,7	2,7	0,8	4,2	0,8	8,4	1,0	15,5	1,2	21,3	1,3	28,1	1,4	52,0	1,6	
1,30	1,1	0,6	1,5	0,7	1,7	0,7	2,9	0,8	4,4	0,9	8,7	1,0	16,2	1,2	22,1	1,3	29,3	1,4	54,1	1,6	
1,40	1,2	0,6	1,5	0,7	1,8	0,7	3,0	0,8	4,6	0,9	9,1	1,1	16,8	1,3	23,0	1,4	30,4	1,5	56,2	1,7	
1,50	1,2	0,7	1,6	0,7	1,8	0,7	3,1	0,8	4,7	0,9	9,4	1,1	17,4	1,3	23,8	1,4	31,5	1,5	58,2	1,8	
2,00	1,4	0,8	1,8	0,8	2,1	0,9	3,5	1,0	5,5	1,1	10,9	1,3	20,1	1,5	27,5	1,6	36,4	1,8	67,2	2,0	
2,50	1,6	0,9	2,0	0,9	2,4	1,0	4,0	1,1	6,1	1,2	12,2	1,5	22,5	1,7	30,8	1,8	40,7	2,0	75,2	2,3	
3,00	1,7	1,0	2,2	1,0	2,6	1,1	4,4	1,5	6,7	1,3	13,3	1,6	24,7	1,9	33,7	2,0	44,6	2,1	82,4	2,5	
3,50	1,9	1,0	2,4	1,1	2,8	1,1	4,7	1,3	7,3	1,5	14,4	1,7	26,6	2,0	36,4	2,2	48,2	2,3			
4,00	2,0	1,1	2,6	1,2	3,0	1,2	5,0	1,4	7,8	1,6	15,4	1,8	28,5	2,1	39,0	2,3	51,5	2,5			
4,50	2,1	1,2	2,8	1,2	3,2	1,3	5,3	1,5	8,3	1,6	16,3	2,0	30,2	2,3	41,3	2,5					
5,00	2,2	1,2	2,9	1,3	3,3	1,4	5,6	1,6	8,7	1,7	17,2	2,1	31,9	2,4							

Table 13: Sizing table for underground and collector pipes conforming to DIN 1986-100, Tab. A.3, filling factor 0.5.

Gradient J cm/m	DN 70 di=68		DN 90 d _i =80,8		DN 100 di=99,4		DN 125 di=114,4		DN 150 di=148,8		DN 200 di=184	
	Q l/s	v m/s	Q l/s	v m/s	Q l/s	v m/s	Q l/s	v m/s	Q l/s	v m/s	Q l/s	v m/s
0,20	0,44	0,24	0,70	0,27	1,21	0,31	1,77	0,34	3,58	0,41	6,67	0,48
0,30	0,54	0,30	0,86	0,33	1,49	0,39	2,18	0,42	4,40	0,51	8,20	0,59
0,40	0,62	0,34	0,99	0,39	1,73	0,45	2,52	0,49	5,09	0,58	9,48	0,68
0,50	0,70	0,38	1,11	0,43	1,94	0,50	2,82	0,55	5,69	0,65	10,61	0,76
0,60	0,77	0,42	1,22	0,48	2,12	0,55	3,09	0,6	6,24	0,72	11,63	0,84
0,70	0,83	0,46	1,32	0,51	2,3	0,59	3,35	0,65	6,75	0,78	12,57	0,91
0,80	0,89	0,49	1,41	0,55	2,46	0,63	3,58	0,70	7,22	0,83	13,45	0,97
0,90	0,94	0,52	1,50	0,58	2,61	0,67	3,80	0,74	7,66	0,88	14,27	1,03
1,00	0,99	0,55	1,58	0,62	2,75	0,71	4,01	0,78	8,08	0,93	15,05	1,08
1,10	1,04	0,57	1,66	0,65	2,89	0,74	4,20	0,82	8,48	0,97	15,79	1,14
1,20	1,09	0,60	1,73	0,68	3,02	0,78	4,39	0,85	8,86	1,02	16,50	1,19
1,30	1,13	0,62	1,80	0,70	3,14	0,81	4,57	0,89	9,22	1,06	17,17	1,24
1,40	1,18	0,65	1,87	0,73	3,26	0,84	4,75	0,92	9,57	1,10	17,83	1,28
1,50	1,22	0,76	1,94	0,76	3,38	0,87	4,92	0,96	9,91	1,14	18,46	1,33
2,00	1,41	0,78	2,24	0,87	3,90	1,01	5,68	1,11	11,45	1,32	21,33	1,54
2,50	1,58	0,87	2,51	0,98	4,37	1,13	6,36	1,24	12,81	1,47	23,86	1,72
3,00	1,73	0,95	2,75	1,07	4,79	1,23	6,97	1,36	14,04	1,61	26,15	1,88
3,50	1,87	1,03	2,97	1,16	5,17	1,33	7,53	1,47	15,17	1,74	28,25	2,04
4,00	2,00	1,10	3,18	1,24	5,53	1,43	8,05	1,57	16,22	1,87	30,21	2,18
4,50	2,12	1,17	3,37	1,32	5,87	1,51	8,54	1,66	17,21	1,98	32,05	2,31
5,00	2,25	1,23	3,56	1,39	6,19	1,60	9,01	1,75	18,15	2,09	33,79	2,43

Table 14: Sizing table for underground and collector pipes using Wavin AS+, filling factor 0.5.

Gradient J cm/m	DN 70 d _i =68		DN 80 d _i =75		DN 90 di=79		DN 100 di=96		DN 125 di=113		DN 150 di=146		DN 200 di=184		DN 225 di=207		DN 250 di=230		DN 300 di=290		
	Q l/s	v m/s	Q l/s	v m/s	Q l/s	v m/s	Q l/s	v m/s	Q l/s	v m/s	Q l/s	v m/s	Q l/s	v m/s	Q l/s	v m/s	Q l/s	v m/s	Q l/s	v m/s	
0,20												5,7	0,5	10,5	0,5	14,4	0,6	19,0	0,6	35,1	0,7
0,30									3,5	0,5	7,0	0,6	12,9	0,6	17,6	0,7	23,3	0,8	43,1	0,9	
0,40							2,6	0,5	4,1	0,5	8,1	0,6	14,9	0,8	20,4	0,8	27,0	0,9	49,9	1,0	
0,50			1,5	0,5	1,7	0,5	2,9	0,5	4,6	0,6	9,0	0,7	16,7	0,8	22,8	0,9	30,2	1,0	55,8	1,1	
0,60	1,3	0,5	1,7	0,5	1,9	0,5	3,2	0,6	5,0	0,7	9,9	0,8	18,3	0,9	25,0	1,0	33,1	1,1	61,2	1,2	
0,70	1,4	0,5	1,8	0,5	2,1	0,6	3,5	0,6	5,4	0,7	10,7	0,9	19,8	1,0	27,1	1,1	35,8	1,2	66,1	1,3	
0,80	1,5	0,5	1,9	0,6	2,2	0,6	3,7	0,7	5,8	0,8	11,5	0,9	21,2	1,1	29,0	1,2	38,3	1,2	70,7	1,4	
0,90	1,6	0,6	2,1	0,6	2,4	0,6	4,0	0,7	6,1	0,8	12,2	1,0	22,5	1,1	30,7	1,2	40,6	1,3	75,0	1,5	
1,00	1,7	0,6	2,2	0,7	2,5	0,7	4,2	0,8	6,5	0,9	12,8	1,0	23,7	1,2	32,4	1,3	42,8	1,4	79,1	1,6	
1,10	1,7	0,6	2,3	0,7	2,6	0,7	4,4	0,8	6,8	0,9	13,5	1,1	24,9	1,3	34,0	1,4	45,0	1,4	83,0	1,7	
1,20	1,8	0,7	2,4	0,7	2,7	0,7	4,6	0,8	7,1	0,9	14,1	1,1	26,0	1,3	35,5	1,4	47,0	1,5	86,7	1,8	
1,30	1,9	0,7	2,5	0,7	2,8	0,8	4,8	0,9	7,4	1,0	14,6	1,2	27,1	1,4	37,0	1,5	48,9	1,6	90,3	1,8	
1,40	2,0	0,7	2,6	0,8	2,9	0,8	5,0	0,9	7,7	1,0	15,2	1,2	28,1	1,4	38,4	1,5	50,8	1,6	93,7	1,9	
1,50	2,0	0,8	2,7	0,8	3,1	0,8	5,1	1,0	7,9	1,1	15,7	1,3	29,1	1,5	39,7	1,6	52,5	1,7	97,0	2,0	
2,00	2,4	0,9	3,1	0,9	3,5	1,0	5,9	1,1	9,2	1,2	18,2	1,5	33,6	1,7	45,9	1,8	60,7	2,0	112,1	2,3	
2,50	2,6	0,9	3,4	1,0	4,0	1,1	6,7	1,2	10,3	1,4	20,3	1,6	37,6	1,9	51,4	2,0	67,9	2,2	125,4	2,5	
3,00	2,9	1,1	3,8	1,1	4,3	1,5	7,3	1,3	11,3	1,5	22,3	1,8	41,2	2,1	56,3	2,2	74,4	2,4			
3,50	3,1	1,2	4,1	1,2	4,7	1,3	7,9	1,5	12,2	1,6	24,1	1,9	44,5	2,2	60,9	2,4					
4,00	3,4	1,2	4,4	1,3	5,0	1,4	8,4	1,6	13,0	1,7	25,8	2,1	47,6	2,4							
4,50	3,6	1,3	4,6	1,4	5,3	1,5	8,9	1,7	13,8	1,8	27,3	2,2	50,5	2,5							
5,00	3,8	1,4	4,9	1,5	5,6	1,5	9,4	1,7	14,6	1,9	28,8	2,3									

Table 15: Sizing table for underground and collector pipes conforming to DIN 1986-100, Tab. A.4, filling factor 0.7.

Gradient J cm/m	DN 70 di=68		DN 90 d _i =80,8		DN 100 di=99,4		DN 125 di=114,4		DN 150 di=148,8		DN 200 di=184	
	Q l/s	v m/s	Q l/s	v m/s	Q l/s	v m/s	Q l/s	v m/s	Q l/s	v m/s	Q l/s	v m/s
0,20	0,73	0,27	1,16	0,30	2,02	0,35	2,94	0,38	5,95	0,46	11,09	0,53
0,30	0,89	0,33	1,42	0,37	2,48	0,43	3,62	0,47	7,31	0,56	13,63	0,66
0,40	1,04	0,38	1,65	0,43	2,88	0,50	4,19	0,55	8,45	0,65	15,76	0,76
0,50	1,16	0,43	1,85	0,48	3,22	0,56	4,69	0,61	9,47	0,73	17,64	0,85
0,60	1,27	0,47	2,03	0,53	3,53	0,61	5,14	0,67	10,38	0,80	19,34	0,93
0,70	1,38	0,51	2,19	0,57	3,82	0,66	5,56	0,72	11,22	0,86	20,91	1,01
0,80	1,47	0,54	2,34	0,61	4,09	0,70	5,95	0,77	12,00	0,92	22,36	1,08
0,90	1,57	0,58	2,49	0,65	4,34	0,75	6,32	0,82	12,74	0,98	23,73	1,14
1,00	1,65	0,61	2,63	0,68	4,57	0,79	6,66	0,87	13,43	1,03	25,02	1,21
1,10	1,73	0,64	2,75	0,72	4,80	0,83	6,99	0,91	14,09	1,08	26,25	1,27
1,20	1,81	0,67	2,88	0,75	5,02	0,86	7,30	0,95	14,72	1,13	27,43	1,32
1,30	1,89	0,69	3,00	0,78	5,22	0,90	7,60	0,99	15,33	1,18	28,55	1,38
1,40	1,96	0,72	3,11	0,81	5,42	0,93	7,89	1,03	15,91	1,22	29,64	1,43
1,50	2,03	0,75	3,22	0,84	5,61	0,97	8,17	1,06	16,48	1,27	30,69	1,48
2,00	2,35	0,86	3,73	0,97	6,49	1,12	9,45	1,23	19,04	1,46	35,46	1,71
2,50	2,62	0,97	4,17	1,09	7,26	1,25	10,57	1,38	21,30	1,64	39,67	1,91
3,00	2,88	1,06	4,57	1,19	7,96	1,37	11,59	1,51	23,35	1,80	43,47	2,09
3,50	3,11	1,15	4,94	1,29	8,60	1,48	12,52	1,63	25,23	1,94	46,97	2,26
4,00	3,33	1,23	5,28	1,38	9,20	1,59	13,39	1,74	26,98	2,08	50,22	2,42
4,50	3,53	1,30	5,61	1,46	9,76	1,68	14,20	1,85	28,62	2,20	53,28	2,57
5,00	3,72	1,37	5,91	1,54	10,29	1,77	14,98	1,95	30,17	2,32	56,17	2,71

Table 16: Sizing table for underground and collector pipes using Wavin AS+, filling factor 0.7.

Gradient J cm/m	DN 70 d _i =68		DN 80 d _i =75		DN 90 d _i =79		DN 100 d _i =96		DN 125 d _i =113		DN 150 d _i =146		DN 200 d _i =184		DN 225 d _i =207		DN 250 d _i =230		DN 300 d _i =290		
	Q l/s	v m/s	Q l/s	v m/s	Q l/s	v m/s	Q l/s	v m/s	Q l/s	v m/s	Q l/s	v m/s	Q l/s	v m/s	Q l/s	v m/s	Q l/s	v m/s	Q l/s	v m/s	
0,20														12,5	0,5	17,2	0,5	22,7	0,5	42,1	0,6
0,30											8,3	0,5	15,4	0,6	21,1	0,6	27,9	0,7	51,7	0,8	
0,40									4,9	0,5	9,6	0,6	17,8	0,7	24,4	0,7	32,3	0,8	59,7	0,9	
0,50							3,5	0,5	5,4	0,5	10,8	0,6	20,0	0,8	27,3	0,8	36,2	0,9	66,9	1,0	
0,60					2,3	0,5	3,9	0,5	6,0	0,6	11,8	0,7	21,9	0,8	30,0	0,9	39,7	1,0	73,3	1,1	
0,70	1,6	0,5	2,1	0,5	2,5	0,5	4,2	0,6	6,5	0,6	12,8	0,8	23,7	0,9	32,4	1,0	42,9	1,0	79,3	1,2	
0,80	1,8	0,5	2,3	0,5	2,6	0,5	4,5	0,6	6,9	0,7	13,7	0,8	25,3	1,0	34,7	1,0	45,9	1,1	84,8	1,3	
0,90	1,9	0,5	2,4	0,6	2,8	0,6	4,7	0,7	7,3	0,7	14,5	0,9	26,9	1,0	36,8	1,1	48,7	1,2	90,0	1,4	
1,00	2,0	0,5	2,6	0,6	3,0	0,6	5,0	0,7	7,7	0,8	15,3	0,9	28,4	1,1	38,8	1,2	51,3	1,2	94,9	1,4	
1,10	2,1	0,6	2,7	0,6	3,1	0,6	5,2	0,7	8,1	0,8	16,1	1,0	29,8	1,1	40,7	1,2	53,8	1,3	99,5	1,5	
1,20	2,2	0,6	2,8	0,6	3,2	0,7	5,5	0,8	8,5	0,8	16,8	1,0	31,1	1,2	42,5	1,3	56,2	1,4	104,0	1,6	
1,30	2,3	0,6	2,9	0,7	3,4	0,7	5,7	0,8	8,8	0,9	17,5	1,0	32,4	1,2	44,3	1,3	58,2	1,4	108,2	1,6	
1,40	2,3	0,6	3,1	0,7	3,5	0,7	5,9	0,8	9,2	0,9	18,2	1,1	33,6	1,3	46,0	1,4	60,8	1,5	112,4	1,7	
1,50	2,4	0,7	3,2	0,7	3,6	0,7	6,1	0,8	9,5	0,9	18,8	1,1	34,8	1,3	47,6	1,4	62,9	1,5	116,3	1,8	
2,00	2,8	0,8	3,7	0,8	4,2	0,9	7,1	1,0	11,0	1,1	21,7	1,3	40,2	1,5	55,0	1,6	72,7	1,8	134,4	2,0	
2,50	3,1	0,9	4,1	0,9	4,7	1,0	7,9	1,1	12,3	1,2	24,3	1,5	45,0	1,7	61,5	1,8	81,4	2,0	150,4	2,3	
3,00	3,5	1,0	4,5	1,0	5,2	1,1	8,7	1,5	13,5	1,3	26,7	1,6	49,3	1,9	67,4	2,0	89,2	2,1	164,8	2,5	
3,50	3,7	1,0	4,9	1,1	5,6	1,1	9,4	1,3	14,5	1,5	28,8	1,7	53,3	2,0	72,9	2,2	96,4	2,3			
4,00	4,0	1,1	5,2	1,2	6,0	1,2	10,1	1,4	15,6	1,6	30,8	1,8	57,0	2,1	77,9	2,3	103,0	2,5			
4,50	4,2	1,2	5,5	1,2	6,3	1,3	10,7	1,5	16,5	1,6	32,7	2,0	60,5	2,3	82,7	2,5					
5,00	4,5	1,2	5,8	1,3	6,7	1,4	11,3	1,6	17,4	1,7	34,5	2,1	63,8	2,4							

Table 17: Sizing table for underground and collector pipes conforming to DIN 1986-100, Tab. A.3, filling factor 0.5.

Gradient J cm/m	DN 70 d _i =68		DN 90 d _i =80,8		DN 100 d _i =99,4		DN 125 d _i =114,4		DN 150 d _i =148,8		DN 200 d _i =184	
	Q l/s	v m/s	Q l/s	v m/s	Q l/s	v m/s	Q l/s	v m/s	Q l/s	v m/s	Q l/s	v m/s
0,20	0,87	0,24	1,39	0,27	2,43	0,31	3,54	0,34	7,15	0,41	13,35	0,48
0,30	1,08	0,30	1,71	0,33	2,99	0,39	4,35	0,42	8,79	0,51	16,39	0,59
0,40	1,25	0,34	1,98	0,39	3,46	0,45	5,04	0,49	10,17	0,58	18,96	0,68
0,50	1,40	0,38	2,22	0,43	3,87	0,50	5,64	0,55	11,39	0,65	21,22	0,76
0,60	1,53	0,42	2,44	0,48	4,25	0,55	6,19	0,6	12,49	0,72	23,27	0,84
0,70	1,66	0,46	2,64	0,51	4,59	0,59	6,69	0,65	13,50	0,78	25,15	0,91
0,80	1,77	0,49	2,82	0,55	4,92	0,63	7,16	0,70	14,44	0,83	26,90	0,97
0,90	1,88	0,52	2,99	0,58	5,22	0,67	7,60	0,74	15,32	0,88	28,54	1,03
1,00	1,99	0,55	3,16	0,62	5,50	0,71	8,01	0,78	16,16	0,93	30,10	1,08
1,10	2,09	0,57	3,31	0,65	5,77	0,74	8,41	0,82	16,95	0,97	31,58	1,14
1,20	2,18	0,60	3,46	0,68	6,03	0,78	8,78	0,85	17,71	1,02	32,99	1,19
1,30	2,27	0,62	3,61	0,70	6,28	0,81	9,15	0,89	18,44	1,06	34,35	1,24
1,40	2,36	0,65	3,74	0,73	6,52	0,84	9,49	0,92	19,14	1,10	35,65	1,28
1,50	2,44	0,76	3,88	0,76	6,75	0,87	9,83	0,96	19,82	1,14	36,91	1,33
2,00	2,82	0,78	4,48	0,87	7,81	1,01	11,36	1,11	22,91	1,32	42,66	1,54
2,50	3,16	0,87	5,02	0,98	8,73	1,13	12,71	1,24	25,63	1,47	47,72	1,72
3,00	3,46	0,95	5,50	1,07	9,57	1,23	13,94	1,36	28,08	1,61	52,29	1,88
3,50	3,74	1,03	5,94	1,16	10,35	1,33	15,06	1,47	30,35	1,74	56,50	2,04
4,00	4,00	1,10	6,36	1,24	11,06	1,43	16,10	1,57	32,45	1,87	60,42	2,18
4,50	4,25	1,17	6,74	1,32	11,74	1,51	17,09	1,66	34,43	1,98	64,09	2,31
5,00	4,48	1,23	7,11	1,39	12,38	1,60	18,01	1,75	36,30	2,09	67,57	2,43

Table 18: Sizing table for underground and collector pipes using Wavin AS+, filling factor 0.5.

Installation

Underground and collector pipes are non-accessible pipes, installed below ground or in foundations, for the disposal of waste water (normally via the connecting sewer). The use of collecting pipes instead of underground and collector pipes is preferred inside buildings, as collecting pipes are easy to inspect, repair and maintain. This does not apply to buildings without a basement. In these cases, the underground and collector pipes leading out of the building area should be kept as short and as straight as possible.

Underground and collector pipes should only be used with drainage sources that are beneath the backflow level and connected to a waste water pump or anti-flooding valve if connection to a collecting pipe is not possible (e.g. floor drains, showers and bathtubs). See also DIN 1986-30.

Careful planning of the underground and collector pipe system is required, as mistakes at the planning and execution stage are difficult to correct later. The spatial location of the underground and collector pipe system is determined by the arrangement of the downpipes, which should make possible (if the layout of the basement permits) an array of various downpipes under the cellar ceiling with as few connections to underground and collector pipes as possible.

- ⦿ Buried underground and collector pipes must measure at least DN 100.
- ⦿ All branches used with underground and collector pipes must have an angle of 45°. Double branches are not permitted.
- ⦿ Changes of direction should be carried out using $\leq 45^\circ$ bends.
- ⦿ Changes of direction with 45° bends located outside the building should be in open or enclosed shafts.
- ⦿ The diameter of an underground and collector pipe must not become smaller along its direction of flow.

Ventilation pipes

Proper aerating and venting are vital for ensuring the correct functioning of the drainage system. Correctly functioning ventilation prevents vacuums and build-ups of excess pressure in the system. Sewage fumes are dissipated, and there is no emptying of the sink traps that prevent smells.



Fig. 20: Changes of direction with 45° bend.



Fig. 21: Shafts with changes of direction.

DIN 1986-100 differentiates between waste water drainage systems as follows:

- ⦿ Single pipe with primary ventilation
- ⦿ Collecting pipe with primary ventilation
- ⦿ Air-circulation conduit
- ⦿ Bypass pipe

Single pipe with primary ventilation

A single pipe with primary ventilation is widely used in small and medium-sized waste water systems.

Downpipes transport both waste water and air at the same time. A pipe with primary ventilation, which is of the same diameter as the downpipe, runs straight up to above roof level. Each downpipe or ventilation pipe should normally run up to above roof level.

Collecting pipe with primary ventilation

Pipes with primary ventilation pipes can be designed as collecting pipes with primary ventilation. In these cases, several single pipes with primary ventilation run into one collecting pipe with primary ventilation.

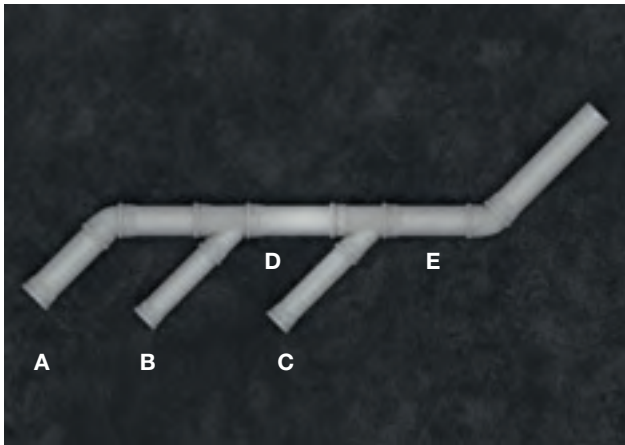

Fig. 22: Example.

Calculation

The rule applied here is that the cross-section of the collecting pipe with primary ventilation must total at least half the sum of the individual cross-sections of the single pipes with primary ventilation. Except in single-family homes, the nominal diameter of the collecting pipe with primary ventilation must, however, be at least one nominal diameter greater than the corresponding single pipe with primary ventilation.

The following therefore applies:

$$ASHL \geq \frac{AEHL_1 + AEHL_2 + \dots + AEHL_n}{2}$$

ASHL cross-section of the collecting pipe with primary ventilation in mm² or cm²

AEHL¹- AEHL_n cross-section of the collecting pipe with primary ventilation in mm² or cm²

Example

Given that:

A multi-occupancy residential building has three single pipes with primary ventilation of DN 90 (A, B, C) that should be grouped into one collecting pipe with primary ventilation.

Objective:

Diameter of the collecting pipes with primary ventilation D+E

3 single pipes with primary ventilation DN 90 (ABC)

DN 90 Wavin AS+

Di = 80.8 mm

Cross-sectional area A = 51.3 cm²

Pipes with primary ventilation B+C run into collecting pipe with primary ventilation D

The following therefore applies:

Cross-sectional area B+C = 2 x 51.3 cm² = 102.6 cm²

102.6 cm²/2 = 51.3 cm². This corresponds to a diameter of DN 90

Assuming the nominal diameter of the collecting pipe with primary ventilation must be at least one nominal diameter bigger than the corresponding single pipe with primary ventilation, collecting pipe with primary ventilation D has a nominal diameter of DN 100. DN 90 would be sufficient in the case of a single-family dwelling.

Single pipes with primary ventilation A, B, and C (all measuring DN 90) run into collecting pipe with primary ventilation E

The following therefore applies:

Cross-sectional area A+B+C = 3 x 51.3 cm² = 153.9 cm²

153.9 cm²/2 = 76.95 cm²

Selected:

Wavin AS+ NG, DN 100

Di = 77.6 cm²

The cross-sectional area of AS NG DN 100 is more than the calculated minimum cross-section, and also one nominal diameter bigger than the single pipes with primary ventilation.

Collecting pipe with primary ventilation E can thus be installed in DN 100 configuration.

Air-circulation pipes

Air-circulation pipes are used to ventilate collecting connection pipes which require such ventilation under certain circumstances, due to the length, height difference or the number of changes of direction; or for functional reasons.

Air-circulation pipes should have the same nominal diameter as the collecting connection pipes that they ventilate, as measured at the confluence with the downpipe. The cross-section of the pipe up to the start of the ventilation system should likewise be of this nominal diameter.



Fig. 23: Air-circulation pipe.

Bypass pipes

Bypass pipes are required under certain circumstances for downpipe offsets or points of confluence between downpipes and underground and collector pipes. Please also refer to the section of this manual that deals with downpipes.

Bypass pipes have the same nominal diameter as the downpipe, but have a maximum diameter of DN 100. The size of the ventilation section (the upper part of the bypass pipe without waste water connection) can be calculated using the following table.

Please note that this table is only a partial extract from DIN EN 12056, Part 2.

It shows only the System I values (i.e. the ones relevant to Germany)

Hydraulic capacity (Q_{max}) and nominal diameter (DN)

Q_{max} (l/s)	Connection pipe / ventilation section (DN)
0.75	50/40
1.50	60/40
2.25	70/50
3.00	80/50**
3.40	90/60***
3.75	100/60

** not applicable to toilets

*** not more than 1 toilet

Table 19: Extract from Table 7, DIN EN 12056-2.

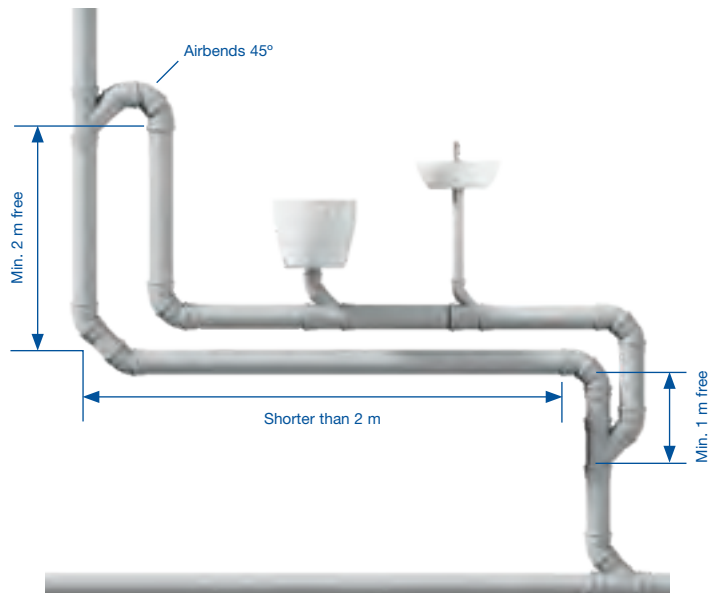

Fig. 24: Bypass pipe conforming to DIN 1986-100.

Ventilation valves

Ventilation valves may be installed in drainage systems equipped with primary ventilation systems, as an alternative to air-circulation or indirect secondary ventilation systems designed to reduce vacuums in the piping system. Only ventilation valves conforming to DIN EN 12380 may be used.

Ventilation valves may be used as a substitute for primary-ventilated pipes in single/two-family residential properties or buildings with comparable residential units with a drainage system only for residential waste water, provided there is at least one downpipe running up to above roof height. In this case, the downpipe with the largest nominal diameter should be aerated/ventilated at above roof height.

Ventilation valves should be installed in such a way that allows them to be replaced without structural building work in the event of a defect. A sufficient supply of air must be guaranteed.

This area of application is subject to the operating temperature and installation position specified in Table 2, in accordance with DIN EN 12380.

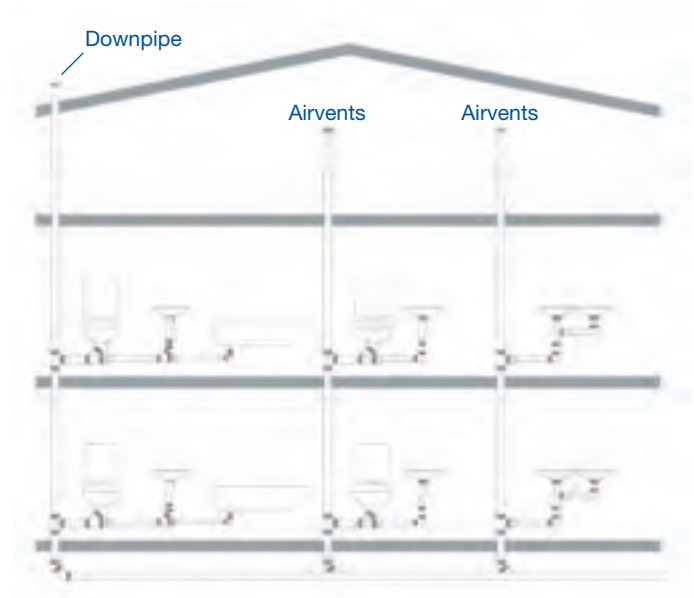

Fig. 25: Use of ventilation valves in single/two-family residential properties.

Ventilation valves must not be used in areas endangered by backflow or for the ventilation containers (e.g. pump stations).

Operating conditions and designation of ventilation valves

Determining factor	Area/position	Designation
Location: Usable beneath flow level ^a of the connection pipe of the connected drainage sources	Yes	A
	No	B
Temperatures	-20°C to +60°C	I
	0°C to +60°C	II
	0°C to +20°C	III

^aFlow level within the meaning of the term “backflow level”, as defined in DIN EN 12380

NOTE Valves corresponding to Designation I are designed for use in places where the ambient temperature at the point of installation (e.g. unheated attics) may drop to below freezing point over several days.

Table 20: Operating conditions and designations of ventilation valves.

Rainwater pipes

Rainwater pipes must be capable of withstanding higher pressures under certain circumstances. Pressures above those foreseen may arise, for example, when overloaded sewers cause build-ups of rainwater. Thrust resistance must be sufficient to guarantee operating safety and reliability in such cases. To ensure this, the sleeves must be fastened using Wavin LKS clamps, for example.

The installation of rainwater pipes is also affected by the issue of condensation. Under certain operating conditions relating to room temperature, relative humidity in the room concerned and the temperature of the rainwater, the dew point of internal rainwater pipes may drop to below that specified.

Diffusion-resistant insulation should normally be fitted to internal rainwater pipes subject to any latent risk of condensation.

Rainwater downpipes/calculation

The minimum dimensions must not be less than the connection diameter of the roof guttering.

Dimensions are calculated subject to rules similar to those governing the layout of collecting pipes described on page 33 of this waste water manual.

The filling factor of r rainwater downpipes totals $f \leq 0.33$

Downpipe deviations $\leq 10^\circ$ are not taken into account when calculating the dimensions of the rainwater downpipe. If downpipe offsets are $\geq 10^\circ$, the sizing should be calculated subject to rules similar to those governing the layout of collecting pipes described in Chapter 4 of this waste water manual.

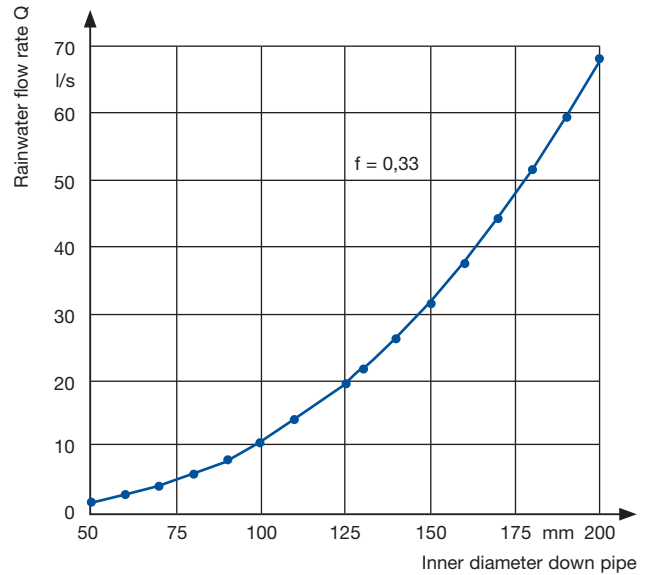

Fig.: 26: Drainage performance of rainwater downpipes.

Nominal diameter DN	Internal diameter Di (mm)
50	44
70	68
90	80.8
100	99.4
125	114.4
150	148.8
200	188

Fig. 27: Nominal width and internal diameter, AS+.

Rainwater collecting pipes/calculation

Rainwater collecting pipes are subject to a filling factor of $h/d_i = 0,7$ and a minimum fall of 0.5%.

This sizing is calculated subject to rules similar to those governing the layout of waste water collecting pipes.

Rainwater underground and collector pipes/calculation

The hydraulic sizing of the rainwater underground and collector pipe should take into account the part of the roof area that provides effective drainage surfaces for the outside of the building, subject at least to the two-year calculation period selected for the surrounding land (duration level "D"), according to the provisions of sections 14.9.2 and 14.9.3 of DIN 1986-100. The larger cross-section at the point of least structural tension resulting from roof drainage is to be taken into account with respect to the direction of flow until the calculation resulting from the two-year calculation period extends the cross-section.

The sizing of rainwater underground and collector pipes is calculated subject to rules similar to those governing the layout of underground and collector pipes for sewage.

The following waste water standards also apply.

Inside the building:

- ⦿ Minimum diameter DN 100
- ⦿ Filling factor $h/d_i = 0.7$
- ⦿ Minimum fall $J = 0.5\%$

The following applies outside the building:

- ⦿ Minimum diameter DN 100
- ⦿ Filling factor $h/d_i = 0.7$
- ⦿ Minimum fall $J = 1: DN$

The minimum flow rate is 0.7 m/s

The maximum flow rate is 2.5 m/s

Dimensions can include complete filling without excess pressure upstream of a drain shaft with open flow.

Installation

The installation of rainwater pipes is subject to similar criteria to those that apply to the installation of sewage pipes inside and outside buildings.

Additional criteria such as dew-point prevention and thrust resistance should also be taken into account. Please refer to the section on rainwater pipes

Mixed-water pipes

Mixed-water systems use a common pipe for waste water and rainwater, running from the building or its surrounding land. As with underground and collector pipes, the minimum diameter of the mixed-water pipe is DN 100.

Calculation

The sizing of mixed-water pipes is subject to the relevant mixed-water discharge rate Q_m , which is in turn based on the respective proportions of waste water discharge Q_{ww} and rainwater outflow Q_r , using the equation

$$Q_m = Q_{ww} + Q_r$$

Whereby

Q_m is the mixed-water discharge rate, in litres per second (l/s);

Q_{ww} is the waste water discharge rate, in litres per second (l/s)

Q_r is the rainwater discharge rate, in litres per second (l/s)

The sizing is calculated subject to rules similar to those governing underground and collector pipes.

Mixed-water pipes outside buildings are subject to the following:

Filling factor $h/d_i = 0.7$

Minimum fall $J = 1: DN$

Minimum flow rate = 0.7 m/s

Maximum flow rate 2.5 m/s

Installation

In the case of mixed systems, rainwater and sewage must leave the building via separate downpipes, collecting pipes or underground and collector pipes. Underground and collector pipes or collecting pipes must, for hydraulic reasons, be jointed together as near as possible to the connecting sewer outside the surrounding land. This jointing should be located in a shaft with open flow.

In exceptional cases (e.g. if the surrounding area is built-up), the waste water and rainwater pipes may only be jointed on the property if this occurs in the direct vicinity of the outer wall of the building.

Application of DN 90

DIN EN 12056 specifies that DN 90 is suitable not only for collecting connection pipes, but also for downpipes and underground and collector pipes. This means that a complete waste water system – from the tap points right down to the first cleaning access or transfer shaft – can be configured using a minimum number of components, allowing the client to save both materials and money.

The DN 90 also offers other advantages compared to the diameter of the DN 100. A nominal diameter of 90 is ideal for connecting water-saving toilets, because the smaller diameter accelerates outflow. For this reason, DIN 1986-100 specifies DN 90 for use with 4 and 4.5-litre water-saving cisterns.

This nominal diameter requires little space when used with today's commonly employed narrow installation shafts

A DN-90 collecting connection conduit can be used as follows:

- ④ Up to a length of 10 m,
- ④ For connecting up to two 6-litre cisterns,
- ④ For connecting up to six items of sanitary equipment,
- ④ For a fall of 1 cm /m (1:100),
- ④ For up to three changes of direction (90° or 2 × 45°).

DN 90 therefore allows buildings of up to ten storeys in height to drain waste water in a functional and norm-compliant way using standard sanitary equipment.

DN 90 can, subject to compliance with the corresponding hydraulic discharge units (flow rate of 0.7-2.5 m/s), also be used to connect to a DN 90 underground and collector pipe that runs up to the property boundary.

5. Installation and jointing

Wavin has designed its low-noise systems to reduce noise emissions in concealed and visible installations. However, to achieve a high level of soundproofing it is strongly recommended to follow the instructions given below.

Push-fit connections between pipes and fittings must be able to withstand thermal-related length changes of up to 10 mm over a maximum length of 3 m. Pipes should therefore be pulled out of the coupling by 10 mm once the join is complete. Push-fit connectors used to join fittings to each other are not subject to changes in length, and can therefore be pushed fully home.

5.1. Connecting Wavin AS+ to fittings and pipes

Wavin AS+ connections are fitted as follows:

- ④ Check the position and condition of the lip seal in the coupler channel. You may have to clean the fitting and lip seal.
- ④ Clean the push-fit end of the pipe and/or fitting.
- ④ Push the end into the coupling so that it goes in fully.
- ④ Slide the pipe (not the fitting) back out of the push-fit coupling by 10 mm

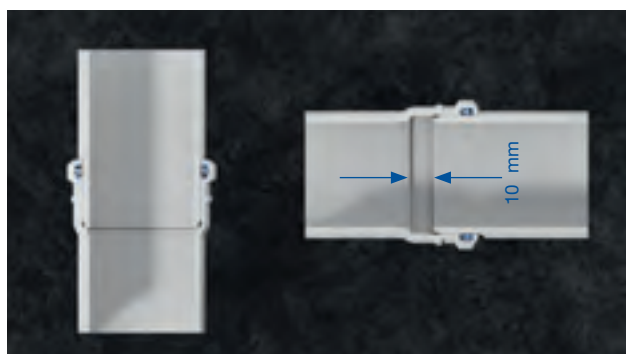

Fig. 28: 10 mm back outside.

When positioning pipes vertically, secure the individual lengths with brackets as soon as they have been fitted. This will prevent them slipping out of place and eliminate the 10 mm dilatation space.

Cutting pipes to size

Pipes can be cut to size using standard pipe cutters. When cutting pipes to length, do so at an angle of 90° to their axis. Remove any burrs or unevenness from the cut ends and rub down sharp edges.



Fixing

In principle, Wavin AS+ soil and waste water pipe systems should be installed tension-free and able to withstand changes in length. The pipes should be secured with sound-absorbing brackets that are compatible with the external diameter of the pipes and completely surround the circumference of the pipes. We recommend the use of Wavin low noise brackets, designed for securing to the brickwork with screws and plastic wall plugs. Metal anchors may also be used, although these do not favour sound insulation.



Installation in brickwork

DIN 1053, Sheet 1, Section 3.5 specifies that recesses and channels may be made in brickwork, provided they do not affect the stability or load-bearing capacity of the structure. In areas subject to high outside temperatures, thermal insulation measures must be applied (e.g. lagging of heating pipes). The key pipe dimensions to be taken into account when installing Wavin AS+ in brickwork recesses can be found in chapter 4 of this manual.

DN	Pipe d_a mm	Coupling d_M mm	Recess depth* t_{erf} mm
50	50	67	125
70	75	91	142
90	90	110	156
100	110	129	179

*These specified recess depths do not include pipe crossings.

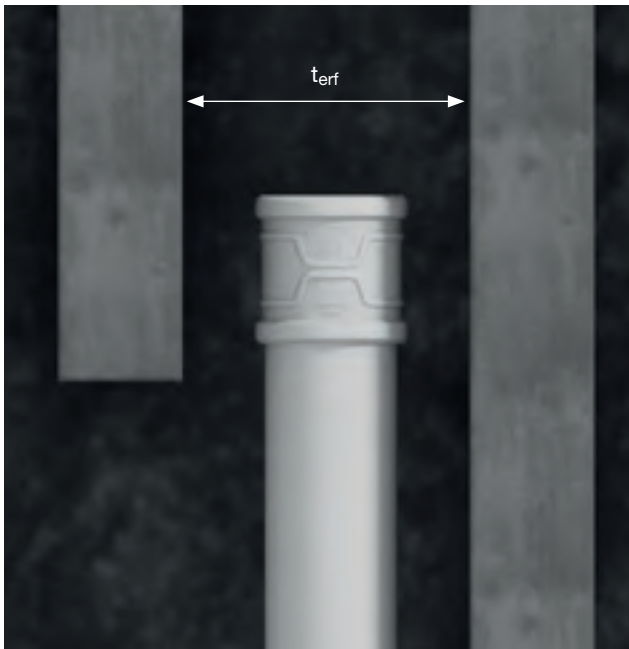

Fig. 29: Example.

Installation in concrete

Like all hollow items, pipes are subject to buoyancy load forces when installed in concrete. All materials used in the pipe structure must be able to withstand these buoyancy loads. To this end, we recommend filling the pipe with water before fitting suitable fixing clamps to the existing steel reinforcement. Wavin Soil & Waste pipe systems (pipes and fittings) can be set in concrete immediately after installation. There is no need to account for any thermal length-expansion of the pipes once they have been installed in keeping with the installation instructions. The pipe sections should be secured properly so as to prevent any change in length, particularly during the pouring of concrete.

To prevent liquid concrete from seeping into the joints, seal the sleeves with adhesive tape (e.g. Tesa Krepp). Exposed pipe ends should also be sealed off. Pour the concrete into the area around the pipe and allow it to flow into the working space. When using a concrete vibrator to compact the concrete, be sure not to come into direct contact with the pipe. If noise-insulating measures are required, insulate the pipe with suitable lagging material before starting work.

Floor crossings

Floor crossings should be made leak-resistant and sound-absorbent. If mastic asphalt is used to cover the floor, the pipe sections located near the floor crossings must be protected



Fig. 30: Floor and wall crossings.

Roof drainage pipes in living areas

Roof drainage pipes projected through living areas can be installed as shown in the example opposite. The specific area weight of the casting should be at least equal to the wall.

The use of condensation insulation is also recommended for Wavin AS+, as installation is subject to a physical law, albeit with a certain time lapse in comparison to metallic materials.

Thrust-resistant connection

Gravity drainage systems (for rain or waste water) can be subject to both planned and unplanned pressure surges. If Wavin AS+ or Wavin SiTech+ is used as a pressure line for a pump station, for example, the resulting pressure surges are planned. If an overloaded rainwater pipe is subject to hydrostatic pressure, however, this counts as an unplanned pressure surge.

For both types of pressure surge, the pipe fittings and groups of fittings must be secured to prevent them from detaching. The Wavin LKS clamp guarantees this for internal pressures of up to 2 bar.

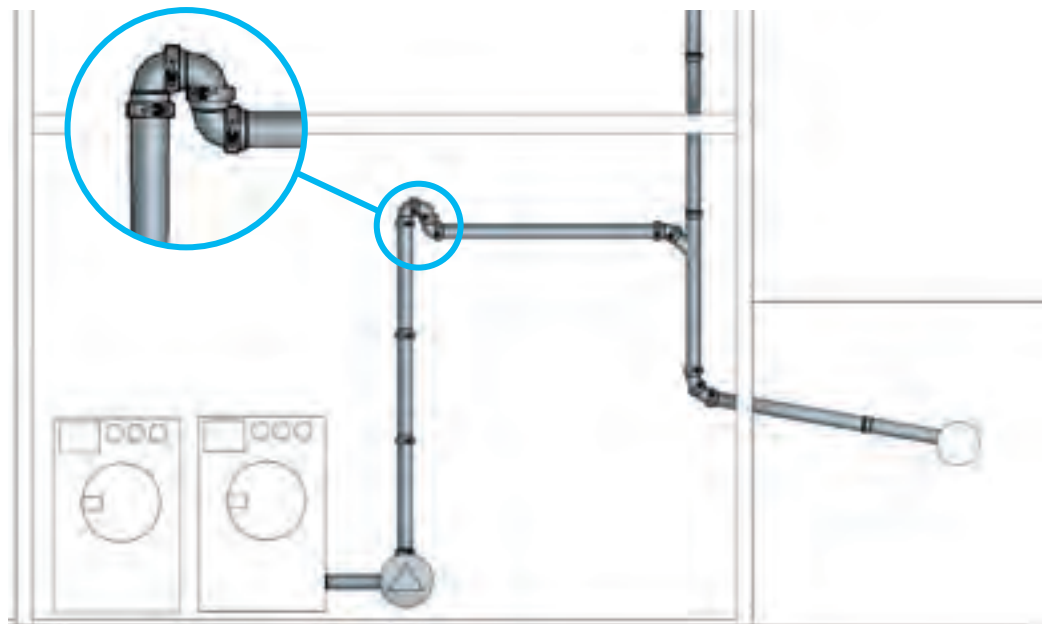

Fig. 31: Thrust resistant connector.

Pressure surges may occur in any part of systems located upstream of pumps and pump stations. All fittings should therefore be secured using LKS clamps. Ensure that the fixings used are able to withstand such pressure surges. The system must be able to transfer dynamic loads to the supporting structure.

In the case of rainwater drainage systems, fittings located at changes of direction are critical. These fittings must therefore be equipped with LKS clamps. Vertical pipes (downpipes) do not require separate LKS clamps. Provided that the fixing specifications provided by us in this manual are observed, the joints on these sections will be suitably secured by the LKS clamp fitted where the change of direction occurs.

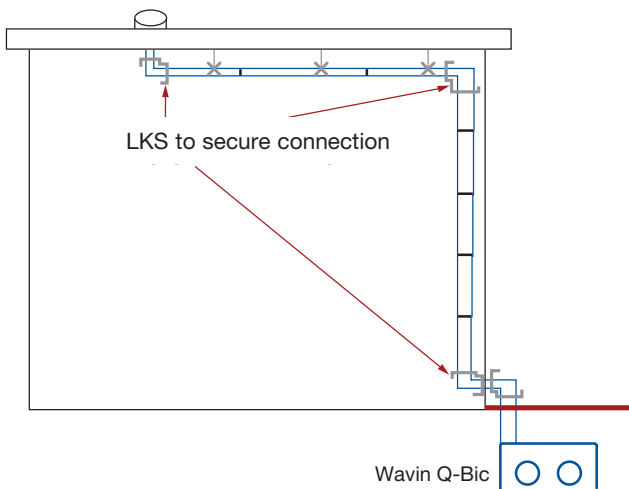

Fig. 32.

Wavin LKS clamps are available for use with Wavin AS+ and SiTech+ sound-insulating pipe systems in sizes DN 50 to DN 150.

For details of the required collar sizes and corresponding article numbers, please refer to page 77 of our AS+ range.



Fig. 33.

Soundproofing

If interior spaces are subject to the technical provisions of DIN 4109 (sound insulation in buildings), with pipe-borne noise not exceeding 30 dB(A), all work must conform to the technical building regulations applying to in-building systems with respect to the configuration of pipes in the context of the corresponding floor plan. Waste water pipes that run through living areas must not be exposed. If they are to run adjacent to such living areas, they may only be installed inside walls with a minimum specific area weight of 220 kg/m² (see supplementary sheet no. 2 of DIN 4109, version of November 1989).

The same conditions apply when installing in brickwork recesses conforming to DIN 1053, with pipes running along the other side of an adjacent wall subject to protection measures, where minimum wall dimensions of 220 kg/m² apply in the area of the recess. Shafts or recesses in brickwork must then be fitted with a supporting structure (matting or metallic mesh) that allows them to be plastered over to a minimum depth 1.5 cm. There must be no sound bridges between the pipe and plaster covering. Preventive measures in this respect include pipe lagging of material classes A1, A2, B1, B2 (e.g. glass fibre, mineral wool or plastic); see also Fig. 40.

As the routing of the pipe has a considerable influence on both the generation and reduction of noise, measures should be taken to minimise its impact. Falling waste water should therefore be directed downwards in stages where possible, i.e. not abruptly, as this would be technically unfavourable. In the case of buildings with more than three storeys (> 10 m), a noise-damping length of 250 mm is fitted between the downpipe and the horizontal pipe. This can take the form of two 45° bends and a corresponding length of pipe (see Fig. 42).

Alternatively, the use of one extended 45° bend and one normal 45° bend is recommended. The waste water pipes should likewise be dimensioned and installed in such a way that allows air to circulate freely around the water being drained. Pipe clamps designed to comply with noise-prevention requirements must be fitted with a suitable rubber insert (see Fig. 41). In the case of bricked-up pipes, note that these must be secured to the underlying structure and not to the new brickwork. Wall and ceiling penetrations must be flexible.



Fig. 34: Extended 45° bend.

Installation of pipe pipes in existing structures

If a pipe is to be connected to an existing system, Wavin AS+ fitting should be used.

Double socket sleeves: Observe the following procedure when using Wavin AS+ double socket sleeves:

1. Leave a sufficiently long section of pipe when cutting it to size (the length of the fitting, plus 2.5 x the external diameter of the pipe)
2. Smooth down any sharp cut edges.
3. Attach the corresponding pipe fitting. Use the cut section of pipe to create a length of pipe that corresponds to the gap.



Fig. 35: Example.



Fig. 36: Example.

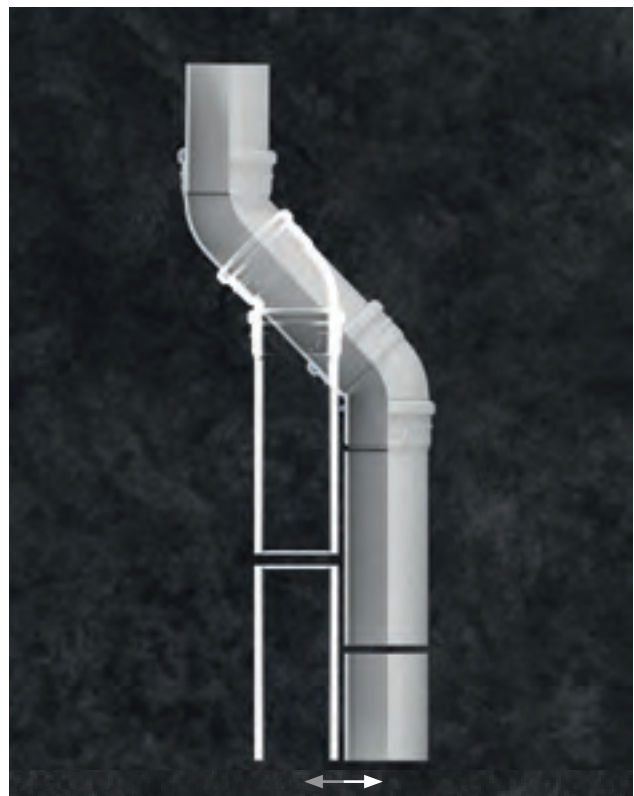

Fig. 37: Example.

4. Then slide both AS+ double socket sleeves fully home onto the end of the pipe or the section of pipe to be fitted in to the gap until the cut end of the pipe fits flush to the second gasket of each double socket sleeve.

5. Pull both double socket sleeves back, and fix them in place

Alternative solutions: Long Wavin sleeves can be used instead of double socket sleeves

Paralell branch

Fixed to the finished floor, in wall-mounted configuration

When fitting to the finished floor in wall-mounted configuration, we recommend the use of a parallel branch matched to the connection dimensions of the wall-mounted item (WC element).

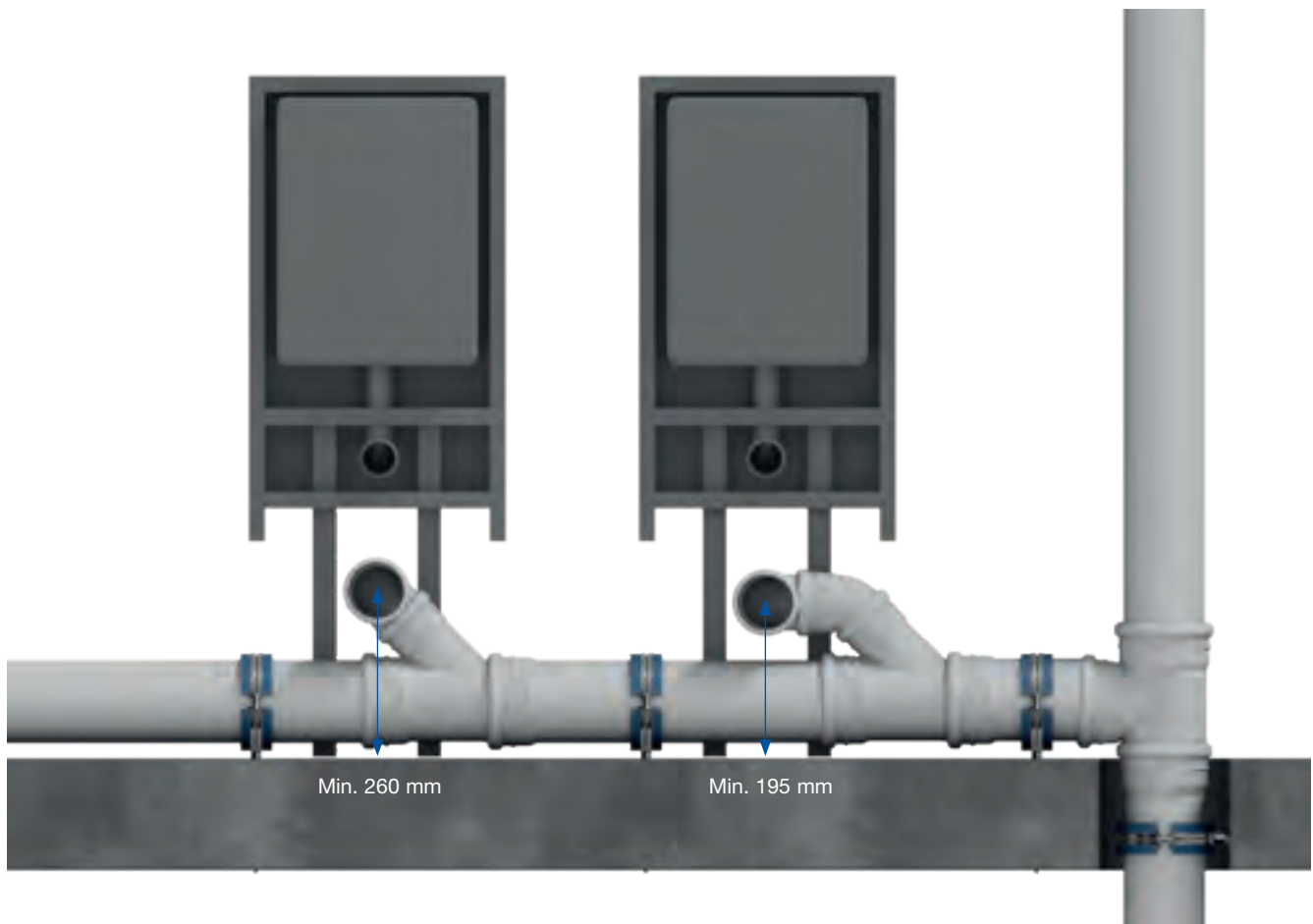

Fig. 38: Example.

5.2. General bracketing rules

5.2.1. Bracket Fixing Instructions

Fixed Bracket

The fixed bracket creates a fixed point in the pipe system. The pipe or fitting cannot be moved through the bracket after the screws are tightened (no longitudinal movement is possible). In order to prevent the vertical stack sliding down, each pipe section between floors must be secured by a fixed bracket. Every horizontally installed pipe length should always be fixed with one fixed bracket. All remaining pipe brackets (vertical and horizontal installation) must be sliding brackets. Taking the prescribed bracket distances into consideration. Use sound absorbing brackets, dimensionally compatible to the pipe diameter. Screw-pipe brackets with rubber inserts are recommended, which are fixed to the wall by screws and plastic plugs.

Sliding Bracket

By using sliding brackets, the pipe can still expand and contract due to temperature changes after the screws are tightened. This make sure longitudinal movement is still possible once installed.



Fixed bracket
** removed distance washer*

Sliding bracket
** distance washer in place*

Changing from sliding to fixed

Wavin low noise brackets are usable as sliding and as fixed bracket. All brackets provided by Wavin are sliding as standard. To change the bracket from sliding to fixed, a distance washer is removed from the bracket before installation. The sliding and fixed brackets can both be completely tightened until the bracket ears touch the distance washers. The distance washers make sure that in any situation, the clamping force on the pipe is perfect. This results in minimal structure borne sound transmission. The distance washers also prevent over-tightening of the brackets, which could otherwise result in a reduction of sound performance.

5.2.2. Bracket Arrangement

During installation of Wavin AS+ pipes, the following should be considered:

- ⦿ In case of horizontal installation, the pipe bracket spacing should be according to table 21 the outside diameter of the pipe. In case of vertical pipe installation, depending on outside diameter, max 2 meter
- ⦿ Generally, pipe brackets should not be installed in impact areas (eg diameter reductions and changes of directions in the system)
- ⦿ Pipe brackets to be fixed to building materials with high specific area weight
- ⦿ For stack pipes in open mounting shafts and high rooms (storey height over 2.5 meters) it is advised to use one fixed bracket and one sliding bracket per pipe length
- ⦿ In buildings under 3 storeys, the fixed bracket must be installed directly above the fitting at the bottom of the pipe end. The sliding bracket must be installed at a distance of maximum of 2 meters above the fixed bracket. This pattern should be repeated on the following floors
- ⦿ In multiple storey buildings (from 3 storeys and more) the stack pipes of 110mm must be secured by additional fixing (stack pipe support) to prevent sliding. In this case we advise using the Wavin AS+ socketed short length with a fixed bracket

		horizontal	vertical	
		15*D	25*D (with exceptions)	
DN	diameter	all situations	between fixed Brackets	between fixed and sliding brackets
	[mm]	[mm]	[mm]	[mm]
DN 50	50	750	1250	1250
DN 70	75	1125	1875	1875
DN 90	90	1350	2250	2000*
DN 100	110	1500*	2750	2000*
DN 125	125	1625*	3125	2000*
Dn 150	160	2000*	3500*	2000*
DN 200	200	2150*	3500*	2000*

* exception to rule

Table 21: Pipe bracket spacing.

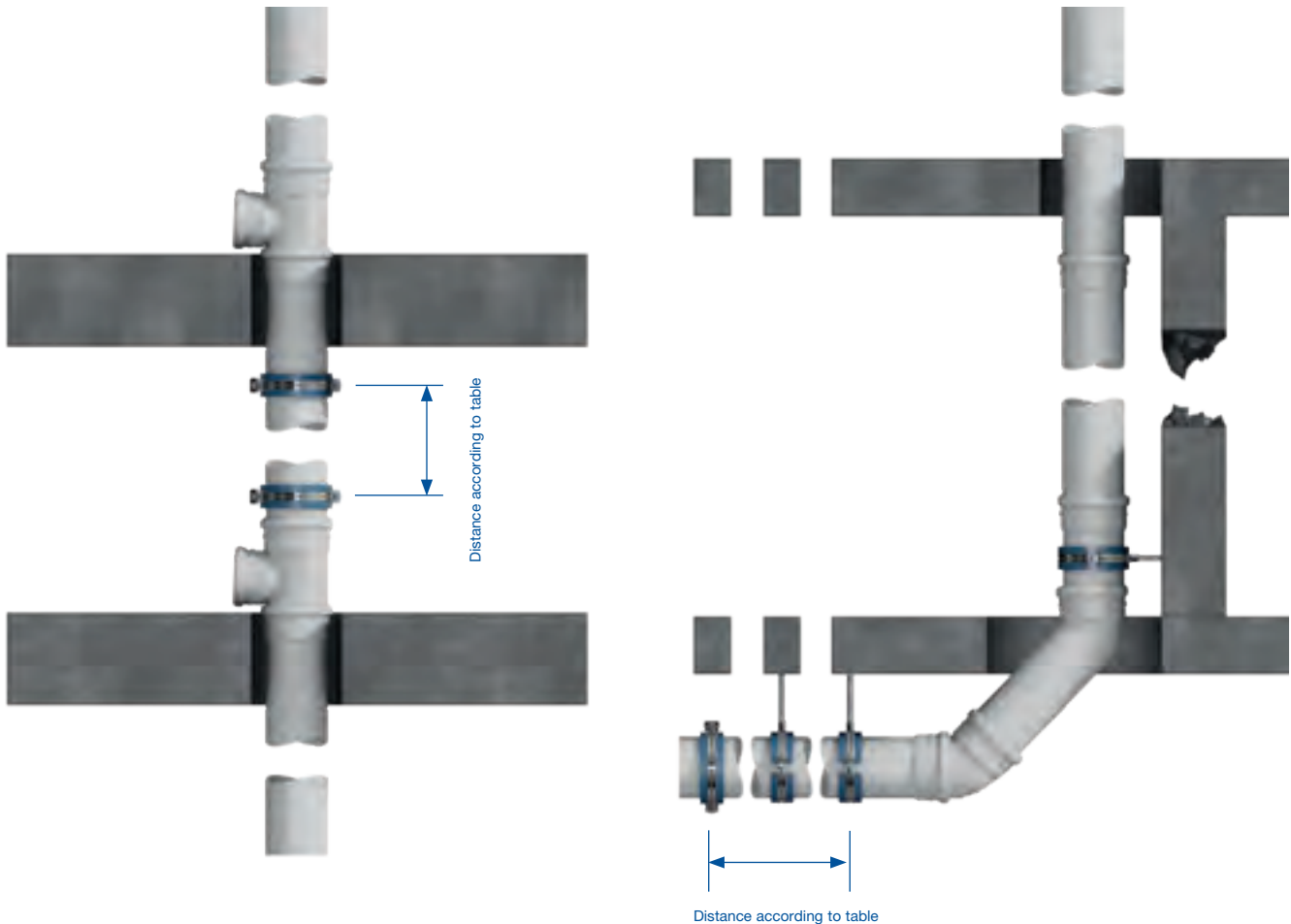

Fig. 39.

5.2.3. Max length of threaded rod

Threaded rods are commonly used for suspension and fixing pipe clamps/brackets. Important to keep in mind is that threaded rods are designed to be used in tension and not typical for bending forces, therefore the length of the threaded rods have predefined maximum lengths. The total maximum length of the threaded rod depends on the strength class. If the strength class is unknown, the lowest strength class of 4.6 should be used. If the strength class is known, the maximum length of the threaded rod can be retrieved from table 22.



	Wall thickness (mm)	Max. length threaded rod M10 (4.6) L= (mm)	Max. length threaded rod M10 (4.8) L= (mm)	Max. length threaded rod M10 (8.8) L= (mm)
Pipe diameter	t	K	K	K
50 mm	3,5	85	115	150
75 mm	4,1	60	80	150
90 mm	5,3	50	70	125
110 mm	6,1	35	45	90
125 mm	6,1	30	40	85
160 mm	6,4	30	40	80
200 mm	6,9	30	40	75

Table 22: Fixing distance to the wall.

5.2.4. Extended wall distance

If the distance from the wall to the pipe is bigger than you can solve with a single threaded rod according to the table ## with the general fixing distances, there are multiple options to increase the distance. The first option is to use the Wavin wall bracket to extend the distance according to table 23. The second option is to mount the pipe brackets to a mounting rail, that is installed parallel to the complete installation of the pipe.

	Wall thickness (mm)	Max. length threaded rod M10 (4.6) L= (mm)	Max. length threaded rod M10 (4.8) L= (mm)	Max. length threaded rod M10 (8.8) L= (mm)
Pipe diameter	t	K	K	K
50 mm	3,5	125	155	190
75 mm	4,1	100	120	190
90 mm	5,3	90	110	165
110 mm	6,1	75	85	130
125 mm	6,1	70	80	125
160 mm	6,4	70	80	120
200 mm	6,9	70	80	115

Table 23: Fixing distance to the wall.

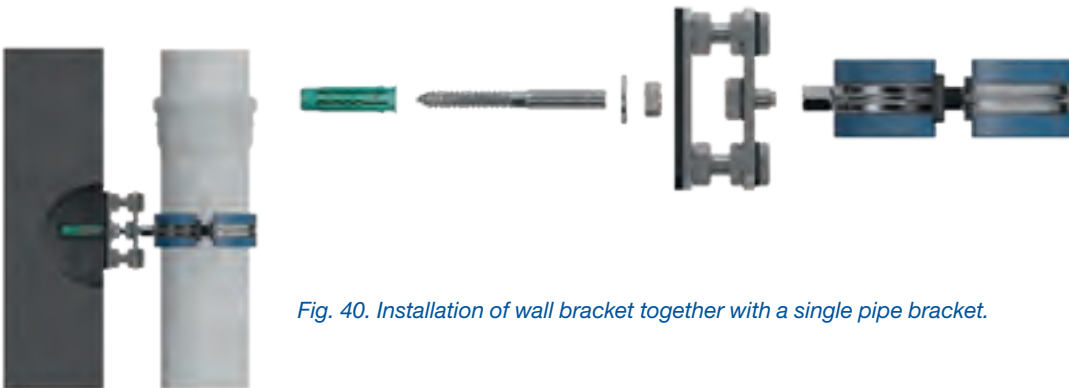

Fig. 40. Installation of wall bracket together with a single pipe bracket.

5.3. Low noise installation – bracketing types

Low noise installation is all about minimizing the transfer of sound (vibration) to connecting rooms. Two types of sound can be distinguished; airborne and structure borne sound. Airborne sound is reduced by the mass of the AS+ pipe, and structure borne sound is reduced by low noise bracketing. For more information about noise reduction, please refer to chapter acoustics.

Wavin offers two types of installation using the Wavin low noise bracket. The single bracket installation offering sound performance as low as 14dB(A), and the No-noise installation offering sound performance lower than 10dB(A).

5.3.1. low noise bracketing – single bracket – 14 dB(A)

The low noise installation makes use of a single “Wavin low noise bracket” that can be used as a sliding and a fixed bracket. The pipe bracket can be changed from sliding to fixed, by removing the distance washer. See 5.2.1. “changing from sliding to fixed”

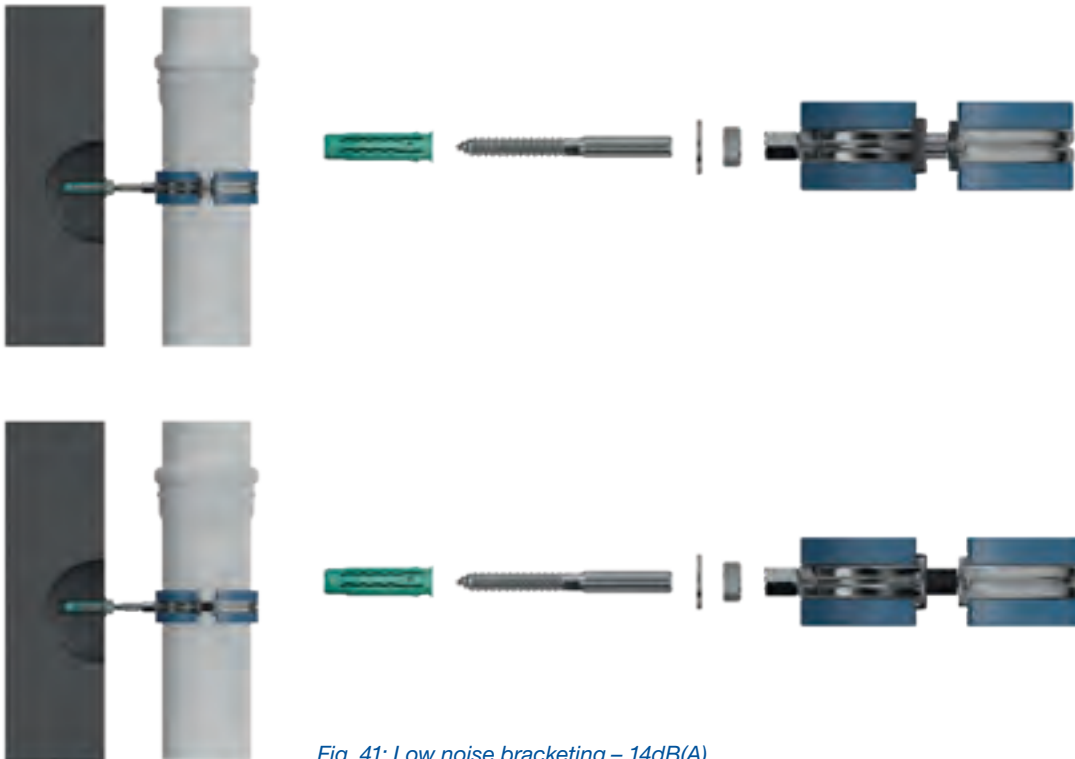
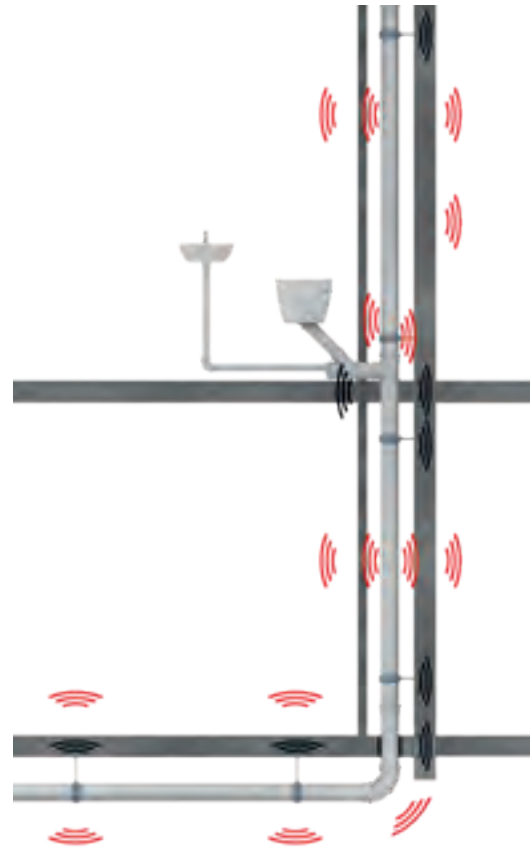

Fig. 41: Low noise bracketing – 14dB(A).

5.2.2 No-noise bracketing – Double bracket – lower than 10 dB(A)

The no-noise type installation makes use of the same “Wavin low noise bracket”, only difference in this installation is the stacked installation of the fixed bracket. The sliding bracket is the same as in the Low noise installation (see paragraph 5.3.1.). Each Wavin low noise bracket contains a rubber inlay that has foam sidewalls. The stacked installation offers further acoustic decoupling, for increased noise performance. The stacked installation consists of a sliding bracket that is mounted to the wall (not exceeding the treaded rod distances in table 22) and a fixed bracket that is mounted to the pipe. In final installed form, the fixed bracket is carried by the sliding bracket.

In the no-noise installation, the distance washers make sure that in any situation, the clamping force on the pipe is perfect. This results in minimal structure borne sound transmission. The distance washers also prevent over-tightening of the brackets, which could otherwise result in a reduction of sound performance.

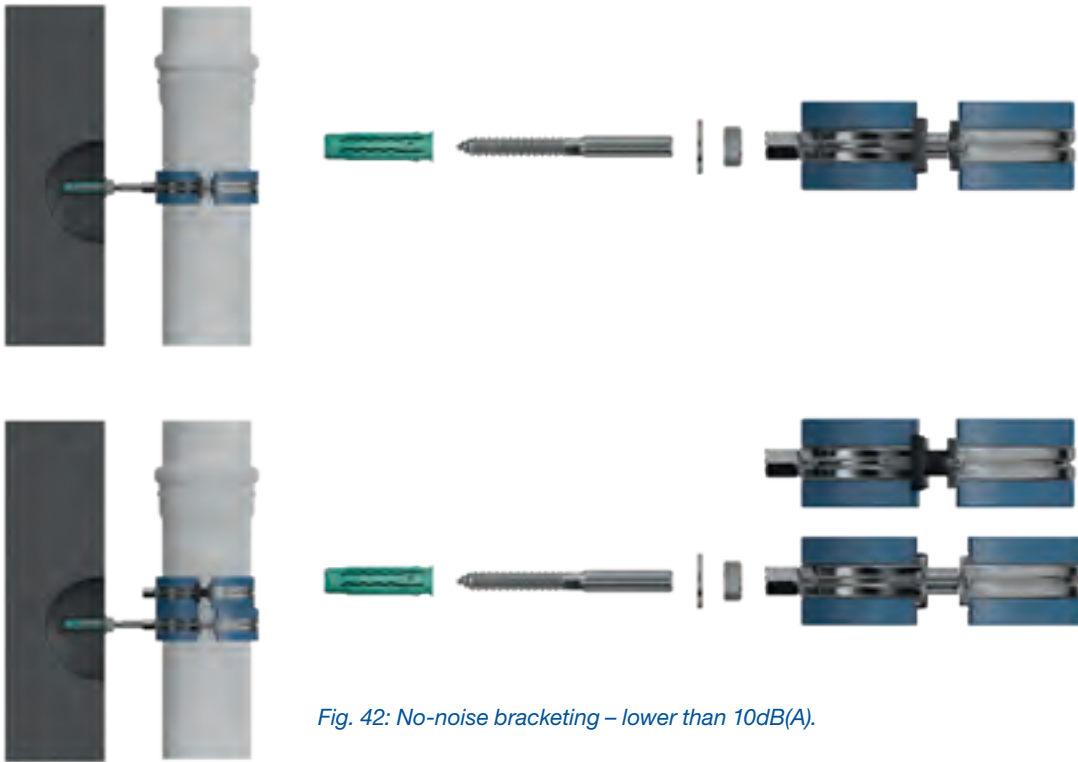

Fig. 42: No-noise bracketing – lower than 10dB(A).

6. Fire protection

6.1 Fire behavior classification

Fire behavior of construction materials, e.g. piping systems and isolation materials, have been defined in fire classification classes as per DIN 4102-1. Construction materials are classified as combustible and non-combustible materials. According to DIN 4102-1 and EN 13501-1, PP, and thus Wavin AS+, is listed as B2 (normally flammable) or according European standard D S₃ do.

Criteria	Old Classification as per DIN 4102-1	New European classification according to DIN EN 13501-1		
		Additional criteria		
Non-combustible	A1 A2	A1 A2	- s1	- d0
Non-readily ignitable (low flame spread)	B1	B C A2 B C A2 B C A2 B C	s1 s1 s2/s3 s2/s3 s2/s3 s1 s1 s1 s3 s3 s3	d0 d0 d0 d0 d0 d1/d2 d1/d1 d1/d2 d2 d2 d2
Normally ignitable (normal fire behavior)	B2	D E D E	s1/s2/s3 - s1/s2/s3 -	d0 d0 d2 d2
Readily ignitable	B3	F	-	-

Table 24: Fire behavior classification according to DIN 4102-1 and DIN EN 13501-1.

In line with European standardization, the fire classification classes as per DIN 4102-1 are translated into the European DIN EN 13501. The accreditation is based on the standardized Singl-burning-Item-Test (SBI) in conformity with DIN EN 13823.

6.2 Fire resistance classification

The fire resistance classification provides the fire resistance duration of a specific construction material.

Fire resistance classification	Fire resistance duration in minutes
F30	≥ 30 = fire retardant
F60	≥ 60 = high fire retardant
F90	≥ 90 = fire resistant
F120	≥ 120 = high fire resistant
F180	≥ 180 = extreme fire resistant

Table 25: Fire resistance classification.

Possible additions to these fire resistance classes, e.g. z.B. F90 A or F90 AB, can be explained as follows:

- A made of non-combustible materials
- B made of combustible materials
- AB in principle made of non-combustible materials

6.3 Wavin fire protection concept

Wavin Fire Protection Collar is in practice the best available solution. The Wavin Fire Protection Collar BM-R90 fully seal the wall or ceiling corridor in case of fire, due to special fire protection material which strongly expands by increased temperature.

The BM-R90 Fire Protection Collar (for Wavin AS+) is especially for sloped piping, suitable up to 45 degrees, and applicable for passages by sleeved pipes or fittings. In practice the collar is suitable to seal off almost any possible configuration.

Fire Protection Collar BM-R90

- ⦿ For wall and ceiling crossings
- ⦿ Suitable for pipes with or without sockets and fittings
- ⦿ Also suitable for angled passages (up to 45 degrees)
- ⦿ Approved for ceiling installation
- ⦿ Applicable for Wavin AS+ from DN50 – 200.
- ⦿ Fire classification F90



Fig. 43: Fire Protection Collar BM-R90.

6.4 Assembly instructions

When the system is applied to a fire-resistant vertical (wall) or horizontal installation (floor) which separated a fire-risk area, only one Fire Protection collar is required. If the system is applied to a fire resistant vertical (wall) or horizontal (floor) installation which separated two fire-risk areas, use a Fire Protection collar on both sides.

Hole

Drill a circular hole into the wall or floor with a diameter of 2 mm greater than the external diameter of the plastic pipe to be used.

Installing the pipe

Insert the PVC, PP, PE etc. pipe in the hole and clean the part the collar is to be applied to.

Closing and sealing against fumes and gas

If there are any gaps between the pipe and the wall, seal these using putty or intumescent strips according to the thickness, to prevent the passage of fumes in the event of a fire.

Cleaning the pipe

The expansion of the intumescent material in the collar completely closes the plastic pipes by a mechanical action. If the pipes are very dirty or have mortar residues, this may delay the action. Clean the surface of the plastic pipe in the point of installation of the fire protection collars.

NB: the fire protection collar can only prevent the passage of fire if it is properly installed

Precautions

In the case of contact of the intumescent material with the eyes, wash delicately with soap and water. Keep out of the reach of children.

Installation manual Wavin fire protection collar BM-R90

Wavin BM-R90 is a new fire protection sleeve designed for use with Wavin domestic waste water removal piping systems according to DIN 4102-11. It is suitable for use on piping with external diameters of up to 200 mm and is able to provide a secure seal for use in all conceivable installation situations:

- ⦿ Right-angled wall and ceiling penetration
- ⦿ Lightly-constructed partition walls
- ⦿ Angled wall and ceiling penetration to 45°
- ⦿ For sealing over pipe collars (to 45°)
- ⦿ For installation under ceilings and in front of walls
- ⦿ Installation flush with ceiling surface

BM-R90 installation instruction

The BM-R90 fire collar provides fire resistant sealing for wall and ceiling installation of the Wavin AS acoustic insulation systems and other selected Wavin soil and waste systems.

General recommendations

(1) Positioning of the collars:

On both sides of a wall; on one side under/in a ceiling (see figure 37).

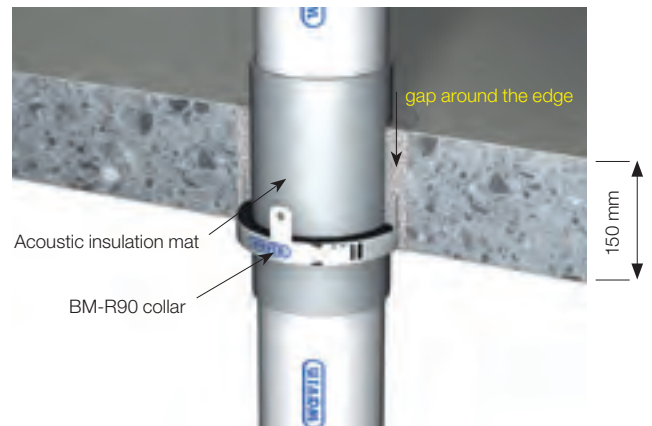

Fig. 44: Straight installation with / without sleeve / socket.

(2) Wall & ceiling types:

At least 10 cm thick solid concrete, aerated concrete and sand-lime brick walls as well as light dividing walls (stud walls: both sides clad with 12.5 mm plasterboard) and solid concrete and aerated concrete ceilings at least 15 cm thick.

(3) Structural acoustic insulation:

The acoustic insulation mat provided must be wrapped around the pipe where it passes through the wall or ceiling.

(4) Joint sealing between pipe and wall/ceiling:

To be packed to the full thickness of the wall or ceiling using mineral materials such as concrete, cement or plaster.



Fig. 45: BM-R90 fire collar.

Components

The fire collars are made from powder coated sheet steel with a push-in fastening and tab fixings with an integrated intumescent material for reliable closure in the event of fire. Also included:

- ④ Insulation mat
- ④ Fixing kit
- ④ Identification label

Selection table

Wavin AS+ pipes DN	d mm	s mm	straight installation	straight installation with collar	angled installation ¹⁾ with sleeve or socket $\leq 45^\circ$ mm
56	50	3,0	63	75	90
70	75	3,5	75	90	110
90	90	4,6	90	110	125
100	110	5,3	110	125	140
125	125	5,3	140	160	180
150	160	5,6	160	180	200
200	200	6,0	200	-	-

¹⁾ The shape of the sleeve must be turned oval by pushing on both sides. In that way the shape of the collar can be adapted when leading-through the pipes (see also figure below)

Table 26: BM-R90 selection table for various types of Wavin AS+ pipe installation.

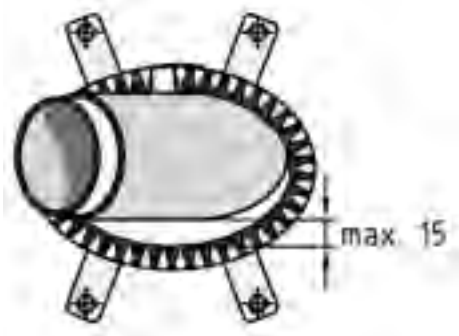

Fig. 46: Maximum allowable gap between pipe and fire protection collar

Types of installation

I. Ceiling installation

Minimum requirements of the ceiling: min. 150 mm thick concrete ceiling.

Flush ceiling installation

Wrap insulating mat around the pipe.

Open the collar and position it around the pipe, whilst hooking in the push-in fastening. Bend or angle the collar mounting tabs. Then install the collar flush with the ceiling. Fill the remaining ceiling gap with cement or concrete (see general recommendations (4)).

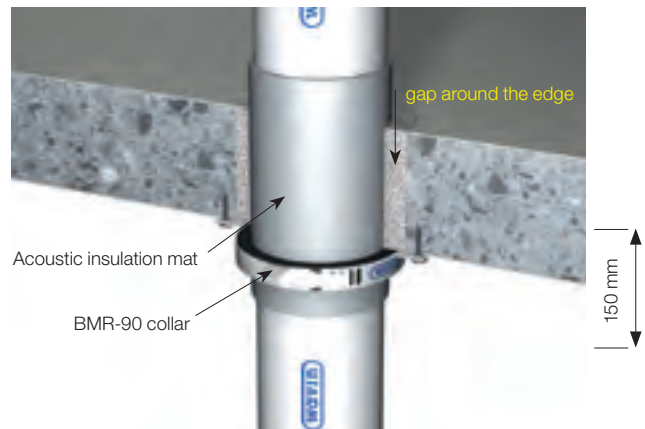

Fig. 47: Straight installation without sleeve / socket up to 160 mm.

II. Installation under the ceiling

Straight ceiling installation

Wrap insulating mat around the pipe. Open the collar and position it around the pipe, whilst hooking in the push-in fastening. Fill the remaining gap with cement or concrete (see general recommendations (4)). Hold the collar firmly against the ceiling and mark the positions of the mounting holes.

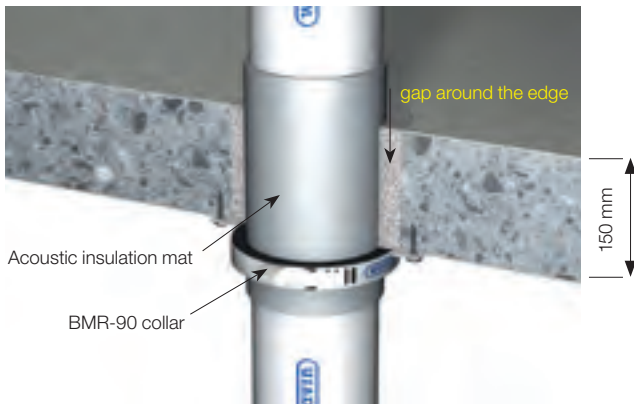

Fig. 48: Straight installation with / without sleeve / socket.

Rotate the collar and drill the holes.

Insert plugs and fix the collar using screws and washers. (Mounting the collar using the washers, plugs and screws provided).

Angled ceiling installation

Wrap insulating mat around the pipe.

Open the collar and position it around the pipe, whilst hooking in the push-in fastening. Fill the remaining gap with cement or concrete (see general recommendations (4)).

Hold the collar firmly against the ceiling and mark the positions of the mounting holes.

Rotate the collar and drill the holes.

Insert plugs and fix the collar using screws and washers. (Mounting the collar using the washers, plugs and screws provided).

Installation distances between BM-R90 fire protection collars eg to external systems

The distance to external, tested systems (inspected and approved) must be at least 50 mm between partitioned sections.

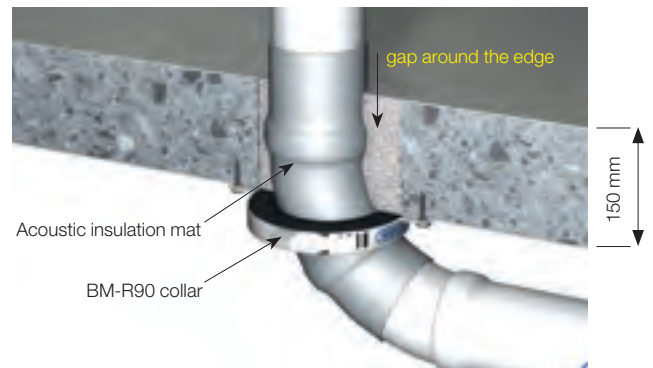

Fig. 49: Angled ceiling installation $\leq 45^\circ$ with / without sleeve socket.

If two Wavin BM-R90 feedthroughs are installed next to each other, the distance between the pipes must be at least 100 mm in the case of special partitioned sections (sloping pipes, partition via sleeve/socket or for ceiling installations). In the case of straight pipes without sleeve/ socket in the partition area, the collar casings can adjoin each other (distance 0 mm).

III. Wall installation

Minimum wall specifications: wall must be at least 100 mm thick, made from concrete, aerated concrete, lime sandstone or lightweight partition walls (two-layer panelling on both sides with 12.5 mm plasterboard panels and mineral wool infill). The pipe must be clamped on both sides at a distance of ≤ 50 cm. For wall feedthroughs, a collar should always be fitted on both sides of the wall.

Wrap insulating mat around the pipe. Open the collar and position it around the pipe, whilst hooking in the push-in fastening. Fill the remaining gap with cement or concrete (see general recommendations (4)). Hold the collar firmly against the ceiling and mark the positions of the mounting holes. Rotate the collar and drill holes.

Insert plugs and fix the collar using screws and washers. (Mounting the collar using the washers, plugs and screws provided).

Repeat the steps described for the second collar required on the opposite side.

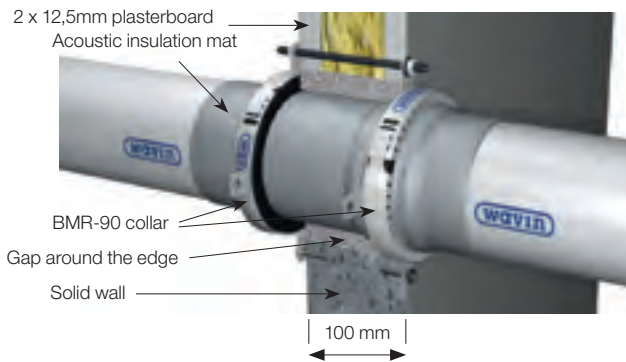

Fig. 50: Straight installation with sleeve / socket.

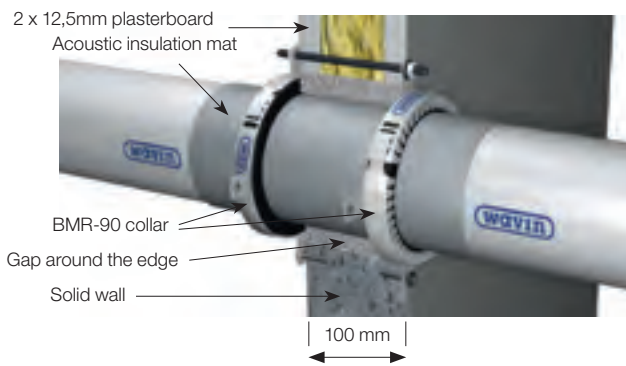

Fig. 51: Straight installation without sleeve / socket.

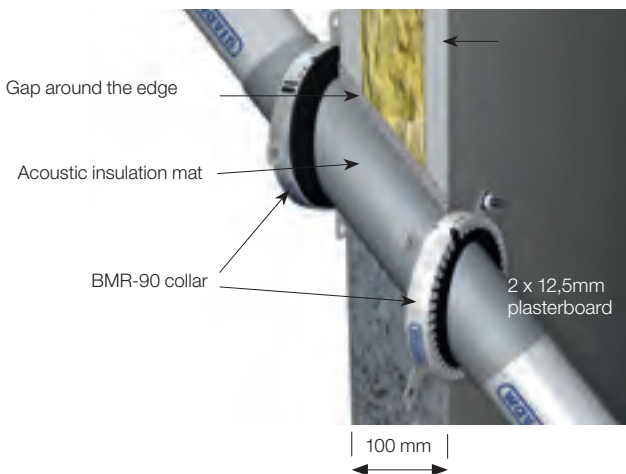

Fig. 52: 45° angled installation with / without sleeve / socket.

The distance to external, tested systems (inspected and approved) must be at least 50 mm between partitioned sections.

If two Wavin BM-R90 feedthroughs are installed next to each other, the distance between the pipes must be at least 100 mm in the case of special partitioned sections (sloping pipes, partition via sleeve/socket or for ceiling installations). In the case of straight pipes without sleeve/ socket in the partition area, the collar casings can adjoin each other (distance 0 mm).

Note

The presented data, especially recommendations for the processing and use of our products are based on our knowledge and experience. Due to differences in material and working conditions that are outside the scope of our influence, we recommend that sufficient internal trials be conducted in each case to ensure the suitability of our product to the intended method and processing purposes. No liability will be accepted either on the basis of these instructions or from an oral advice, unless we are accused of gross negligence or deliberate malice.

7. Packing, transport & storage

Handling

Handle pipes and fittings with care. Excessive scratching or impact damage on pipes can affect the external structure or impair its sealing performance. Loose pipes must be unloaded by hand. If pipes have been inserted into other pipes, always remove the inner pipe first. We recommend the use of nylon-covered or plastic forks when unloading bundles of pipes with a forklift truck. Do not allow metal forks, hooks or chains to come into contact with the pipes. Do not use extended forks. If you intend to load or unload with a crane or excavator arm, attach a sling of sufficient width at the centre of the pipes.

Transport of loose Wavin pipes.

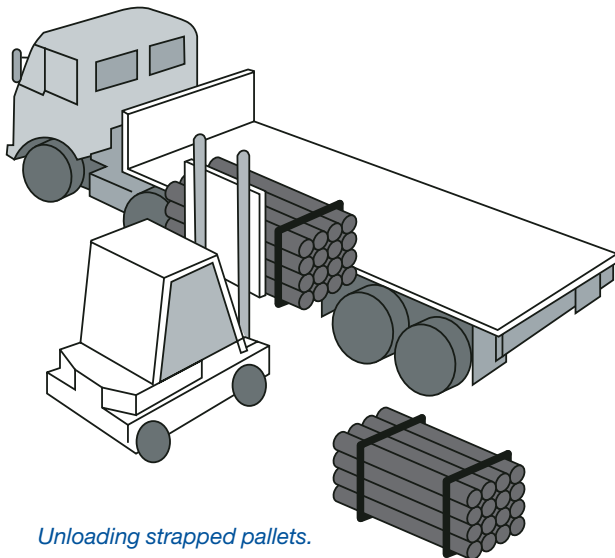
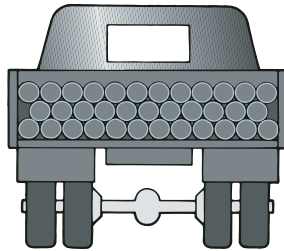

Unloading strapped pallets.

Transport

If Wavin AS+ pipes are no longer in their original packing, they must be fully supported along their entire length and placed on a clean surface for transport. Avoid any bending of the pipes. Protect the pipe ends and fittings from impact damage.

Storage

Always store pipes on a flat surface. Pallets may be stacked up to a maximum height of 1.5 m without additional supports or side protection. Loose pipes must be held in place by at least 2 side supports spread evenly across their length. When storing, loose pipes may be stacked up to a maximum height of 1.5 m, preferably supported along their entire length. If this is not possible, place wooden supports with a minimum width of 75 mm under the pipes and spaced no more than 1 m apart.

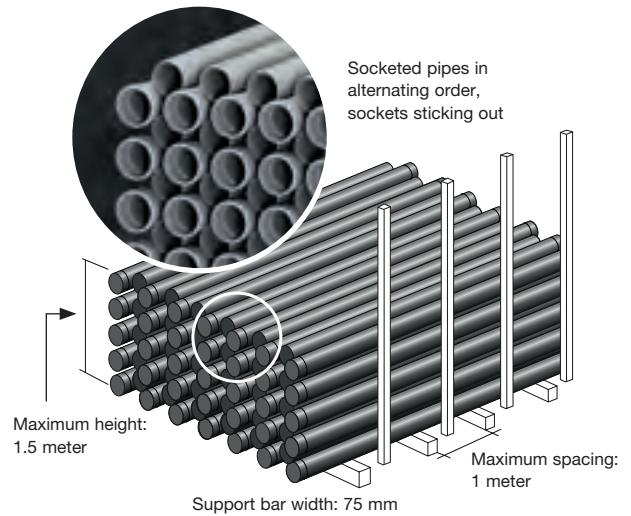

Stack pipes of different sizes separately or, if this is not possible, stack them in such a way that the largest diameter pipes are at the bottom. Pipes with sleeves should be stacked alternately so that they are supported along their entire length (see picture). Fittings are supplied in boxes and must be stored indoors. Do not subject fittings to heavy loads, as this can deform them.

8. Wavin AS+ product range

* Available in Q1 2020

* Available in Q1 2020

	DN 50	DN 70	DN 90	DN 100	DN 125	DN 150	DN 200
Pipe 	✓	✓	✓	✓	✓	✓	✓
Double Socket Coupler 	✓	✓	✓	✓	✓	✓	✓
Bend 	✓	✓	✓	✓	✓	✓	✓
Long bend 			✓	✓			
Trap bend 	✓						
Trap straight	✓						
Branch 	✓	✓	✓	✓	✓	✓	✓
Double branch 			✓	✓			
Corner branch 			✓	✓			
Parallel branch 			✓	✓			
Combination branch 				✓			
Shower branch 			✓	✓			
Double socket sleeve 	✓	✓	✓	✓	✓	✓	✓

* Available in Q1 2020

* Available in Q1 2020

		DN 50	DN 70	DN 90	DN 100	DN 125	DN 150	DN 200
Long socket		✓	✓	✓	✓	✓	✓	✓
Socket Plug		✓	✓	✓	✓	✓	✓	✓
Reducer			✓	✓	✓	✓	✓	✓
Access Pipe		✓	✓	✓	✓	✓	✓	✓
Bracket		✓	✓	✓	✓	✓	✓	✓
Covering Clamp type LKS		✓	✓	✓	✓	✓	✓	✓
Gasket EPDM		✓	✓	✓	✓	✓	✓	✓
Gasket NBR		✓	✓	✓	✓	✓	✓	✓
Gasket rubber for Siphon 1 1/2" 53 mm								
Gasket rubber for Siphon 1 1/4" 53 mm								
BM-R90		✓	✓	✓	✓	✓	✓	✓
EPDM Flex coupler for connecting AS with AS+		✓	✓			✓		

Wavin AS+ product range

PIPE

Title

DN	Outer diameter Do1 = Ds2	Wallthickness s	Length of socket P2
50	50	3,0	46
70	75	3,5	51
90	90	4,6	55
100	110	5,3	59
125	125	5,3	63
150	160	5,6	71
200	200	6,0	86

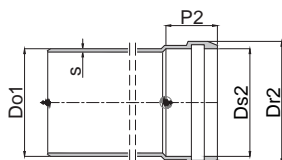

Wavin AS+ Pipe with socket



Diameter DN	Article Nr.	Do1 mm	L mm	Ds2 mm	Z1 mm	Weight kg/PC
50	3080057	50	198	50	150	0,180
50	3080058	50	298	50	250	0,262
50	3080059	50	546	51	500	0,437
50	3080060	50	1046	51	1000	0,825
50	3080061	50	2046	51	2000	1,605
50	3080062	50	2746	51	2700	2,150
50	3080063	50	3046	51	3000	2,383
70	3080064	75	202	75	150	0,297
70	3080065	75	302	75	250	0,442
70	3080066	75	551	76	500	0,787
70	3080067	75	1051	76	1000	1,490
70	3080068	75	2051	76	2000	2,896
70	3080069	75	2751	76	2700	3,880
70	3080070	75	3051	76	3000	4,302
90 *	3080071	90	205	90	150	0,465
90 *	3080072	90	305	90	250	0,692
90 *	3080073	90	554	91	500	1,250
90 *	3080074	90	1054	91	1000	2,366
90 *	3080075	90	2054	91	2000	4,597
90 *	3080076	90	2754	91	2700	6,160
90 *	3080077	90	3054	91	3000	6,829
100	3080030	110	209	111	150	0,675
100	3080031	110	309	111	250	1,017
100	3080032	110	559	111	500	1,830
100	3080033	110	1059	111	1000	3,407

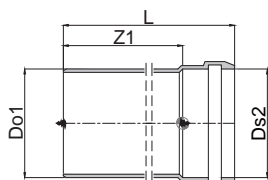



Diameter DN	Article Nr.	Do1 mm	L mm	Ds2 mm	Z1 mm	Weight kg/PC
100	3080034	110	2059	111	2000	6,562
100	3080035	110	2759	111	2700	8,770
100	3080036	110	3059	111	3000	9,716
125	3080037	125	213	125	150	0,788
125	3080038	125	313	125	250	1,155
125	3080039	125	562	126	500	2,092
125	3080040	125	1062	126	1000	3,895
125	3080041	125	2062	126	2000	7,502
125	3080042	125	2762	126	2700	10,026
125	3080043	125	3062	126	3000	11,109
150	3080044	160	221,4	160	150	1,088
150	3080045	160	321,4	160	250	1,088
150	3080046	160	570,2	161	500	2,865
150	3080047	160	1070	161	1000	5,334
150	3080048	160	2070	161	2000	10,272
150	3080049	160	2770	161	2700	13,730
150	3080050	160	3070	161	3000	15,211
200 *	3080051	200	328	201	250	2,05
200 *	3080052	200	584	201	500	4,145
200 *	3080053	200	1084	201	1000	7,488
200 *	3080054	200	2084	201	2000	14,172
200 *	3080055	200	2784	201	2700	18,852
200 *	3080056	200	3084	201	3000	20,857

* Available in Q1 2020

FITTINGS

Wavin AS+ Double socket coupler

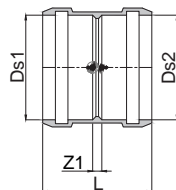

Diameter DN	Article Nr.	L mm	Ds1 mm	Ds2 mm	Z1 mm	Weight kg/PC
50	3080016	99	50	50	3	0,123
70	3080017	107	75	75	3	0,174
90 *	3080018	114	90	90	3	0,263
100	3080012	124	111	111	5	0,391
125	3080013	132	125	125	5	0,512
150	3080014	148	160	160	5	0,755
200 *	3080015	181	201	201	8	1,327

* Available in Q1 2020

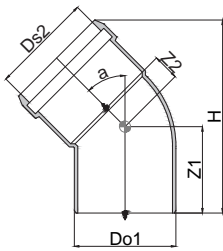

Wavin AS+ Bend > 15°, 30°, 45°, 67°, 87°

Diam. DN	a	Article Nr.	Do1 mm	Ds2 mm	Z1 mm	Z2 mm	h mm	Weight kg/PC
50	15°	3079965	50	50	53	11	115	0,108
50	30°	3079966	50	51	57	13	122	0,115
50	45°	3079967	50	51	60	18	126	0,124
50	67°	3079968	50	51	68	23	124	0,130
50	87	3079969	50	51	74	32	111	0,146
70	15°	3079970	75	75	59	11	129	0,179
70	30°	3079971	75	75	64	15	141	0,193
70	45°	3079972	75	75	70	21	150	0,217
70	67°	3079973	75	75	79	29	150	0,229
70	87°	3079974	75	75	90	41	141	0,251
90 *	15°	3079975	90	90	64	15	141	0,299
90 *	30°	3079976	90	90	70	20	157	0,324
90 *	45°	3079977	90	91	73	25	167	0,364
90 *	67°	3079978	90	90	88	37	172	0,390
90 *	87°	3079979	90	90	101	49	160	0,428
100	15°	3079950	110	110	70	17	157	0,466
100	30°	3079951	110	110	77	20	177	0,517
100	45°	3079952	110	110	85	32	192	0,565
100	67°	3079953	110	110	99	44	197	0,606
100	87°	3079954	110	110	114	61	186	0,694
125	15°	3079955	125	125	75	17	167	0,568
125	30°	3079956	125	125	83	25	191	0,628
125	45°	3079957	125	125	92	34	208	0,632
125	87°	3079958	125	125	126	67	206	0,864
150	15°	3079959	160	160	85	19		0,852
150	30°	3079960	160	160	96	28		0,950
150	45°	3079961	160	160	108	42		1,075
150	87°	3079962	160	160	151	84		1,384
200 *	45°	3079963	200	201	132	51		1,814
200 *	87°	3079964	200	201	185	42		2,314

* Available in Q1 2020

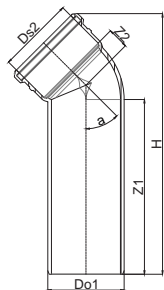

Wavin AS+ Long bend > 45°

Diam. DN	Article Nr.	Do1 mm	Ds2 mm	Z1 mm	h mm	Weight kg/PC
90 *	3080027	90	90	250	25	0,807
100	3080026	110	110	250	25	1,137

* Available in Q1 2020

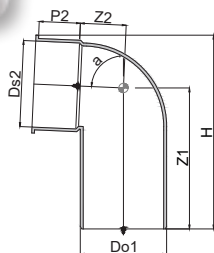

Wavin AS+ Trap

Diam. DN	a	Article Nr.	Do1 mm	Ds2 mm	Z1 mm	Z2 mm	h mm	Weight kg/PC
50	87°	3080101	50	53	79	35	123	0,051

Wavin AS+ Trap straight

Diam. DN	a	Article Nr.	Do1 mm	Ds2 mm	Z1 mm	Z2 mm	h mm	Weight kg/PC
50		3080102	50	53	55	40	120	0,051

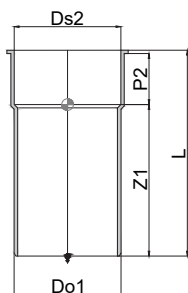

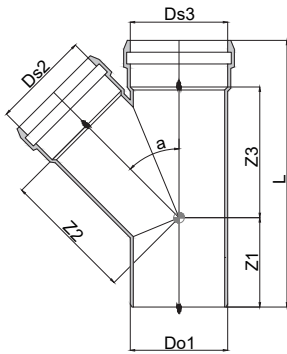

Wavin AS+ Branch > 45° and 87°

Diam. DN	a	Article Nr.	Do1 mm	L mm	Ds2 mm	Ds3 mm	Z1 mm	Z2 mm	Z3 mm	Weight kg/PC
50/50	45°	3079996	50	171	50	50	60	62	62	0,250
	87°	3079997	50	150	50	50	75	29	29	0,202
70/50	45°	3079998	75	178	50	75	52	82	78	0,336
	87°	3079999	75	158	50	75	78	42	30	0,291
70/70	45°	3080000	75	215	75	75	69	95	95	0,442
	87°	3080001	75	183	75	75	90	45	42	0,343
90/50 *	45°	3080002	90	185	50	90	55	93	77	0,487
	87°	3080003	90	186	50	90	82	52	30	0,432
90/70 *	45°	3080004	90	220	75	90	65	106	103	0,610
	87°	3080005	90	191	75	90	93	49	45	0,495
90/90 *	45°	3080006	90	243	90	90	76	114	114	0,757
	87°*	3080007	90	224	90	90	124	68	48	0,646
100/50	45°	3079982	110	197	50	110	59	106	81	0,689
	87°	3079983	110	178	50	110	85	59	36	0,637
100/70	45°	3079984	110	230	75	110	59	120	114	0,836
	87°	3079985	110	200	75	110	97	59	46	0,695
100/90	45°	3079986	110	249	90	110	69	128	123	0,986
	87°	3079987	110	216	90	110	105	60	55	0,791
100/100	45°	3079981	110	277	111	110	83	194	138	1,216
	87°*	3079980	110	253	110	110	136	77	56	1,061
125/100	45°	3079988	125	291	110	125	81	152	149	1,410
	87°	3079989	125	241	110	125	118	70	63	1,056
125/125	45°	3079990	125	310	125	125	91	158	158	1,607
150/100	45°	3079991	160	304	110	160	71	175	165	1,822
	87°	3079992	160	256	110	160	124	87	6	1,424
150/125	45°	3079993	160	326	125	160	82	184	176	2,029



Diam. DN	a	Article Nr.	Do1 mm	L mm	Ds2 mm	Ds3 mm	Z1 mm	Z2 mm	Z3 mm	Weight kg/PC
150/150	45°	3079994	160	375	160	160	108	200	199	2,519
200/200	* 45°	3079995	200	460	201	201	128	250	250	4,259

*with internal radius

* Available in Q1 2020

Wavin AS+ Double branch > 87°



Diam. DN	a	Article Nr.	Do1 mm	L mm	Ds2 mm	Ds3 mm	Ds4 mm	Z1 mm	Z2 mm	Z3 mm	Z4 mm	Weight kg/PC
90/90/90*	*	3080011	90	224	90	124	68	48	0,820			
100/100/100*		3080010	110	255	110	139	81	60	1,263			

*with internal radius

* Available in Q1 2020

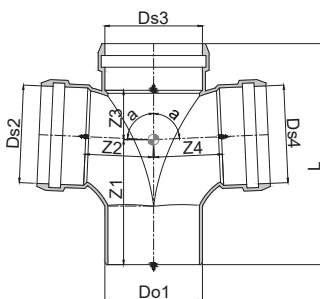

Wavin AS+ Corner branch > 87°



Diam. DN	a	Article Nr.	Do1 mm	L mm	Ds2 mm	Ds3 mm	Ds4 mm	Z1 mm	Z2 mm	Z3 mm	Z4 mm	Weight kg/PC
90/90/90*	*	3080009	90	218	90	111	66	51	51	0,856		
100/100/100		3080008	110	251	110	122	139	128	139	1,131		

* Available in Q1 2020

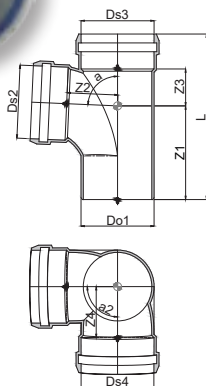



Wavin AS+ Paralell branch

Diam. DN	Article Nr.	Do1 mm	L mm	Ds2 Ds3 mm	Z mm	Z1 mm	Z2 mm	Z3 mm	E mm	Weight kg/PC
90/90 *	3080029	90	260	90	151	74	25	118	105	0,684
100/100	3080028	110	303	110	186	87	32	145	130	1,138

* Available in Q1 2020

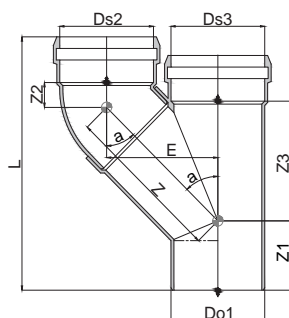

Wavin AS+ Combi Branch

Diam. DN	Article Nr.	Ds1 Ds3 mm	Ds4 mm	Ds2 mm	Z1 mm	Z2 mm	Z3 mm	Z4 mm	Z5 mm	Weight kg/PC
100/100/70	3080109									

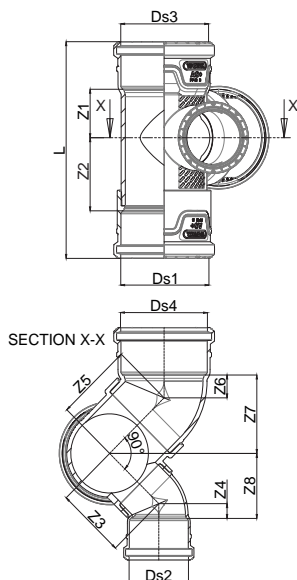



Wavin AS+ Showerdouble branch > 87°

Diam. DN	Article Nr.	Do1 mm	L mm	Ds2 mm	Ds3 mm	Ds4 mm	Z mm	Z1 mm	Z2 mm	Z3 mm	Weight kg/PC
90/90/50 *	3080098	90	296	50	90	114	82	51	68		1,11
90/90/70 *	3080111	90	296	75	90	114	82	51	68		1,18
100/100/50	3080095	110	330	50	110	126	87	59	81		1,78
100/100/70	3080110	110	330	75	110	126	87	59	81		1,83

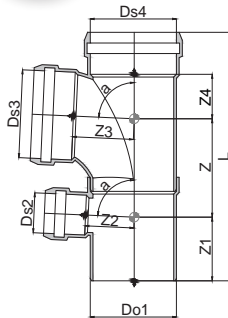

* Available in Q1 2020



Wavin AS+ Showerdouble branch > 87° > left

Diam. DN	Article Nr.	Do1 mm	L mm	Ds2 mm	Ds3 mm	Ds4 mm	Z mm	Z1 mm	Z2 mm	Z3 mm	Weight kg/PC
90/90/50 *	3080099	90	296	50	90	114	82	51	68		1,11
100/100/50	3080096	110	330	50	110	126	87	59	81		1,78

* Available in Q1 2020

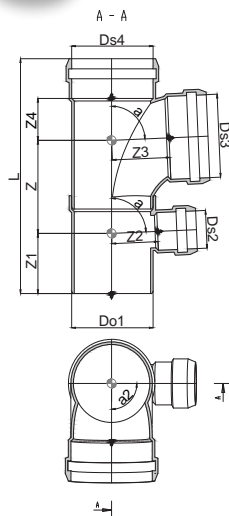

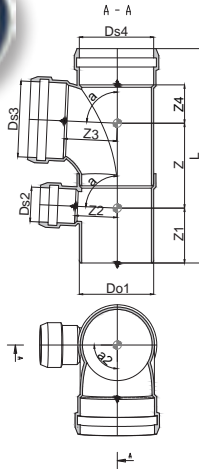

Wavin AS+ Showerdouble branch > 87° > right

Diam. DN	Article Nr.	Do1 mm	L mm	Ds2 mm	Ds3 Ds4 mm	Z mm	Z1	Z2	Z3	Weight kg/PC
90/90/50 *	3080100	90	296	50	90	114	82	51	68	1,11
100/100/50	3080097	110	330	50	110	126	87	59	81	1,78

* Available in Q1 2020

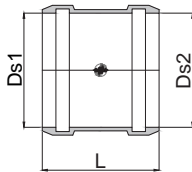

Wavin AS+ Repair coupler

Diam. DN	Article Nr.	L mm	Ds1 mm	Ds2 mm	Weight kg/PC
50	3080092	99	50	50	0,121
70	3080093	107	75	75	0,170
90 *	3080094	114	90	90	0,263
100	3080088	124	110	110	0,387
125	3080089	132	125	125	0,512
150	3080090	148	160	160	0,755
200 *	3080091	181	201	201	

* Available in Q1 2020

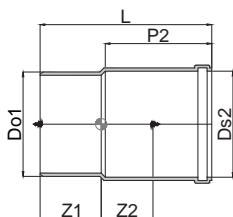

Wavin AS+ Long socket

Diam. DN	Article Nr.	Do1 mm	L mm	Ds2 mm	P2 mm	Z1	Z2	Weight kg/PC
50	3080023	50	184	50	105	57	60	0,178
70	3080024	75	199	75	129	62	66	0,268
90 *	3080025	90	202	90	125	66	92	0,421
100	3080019	110	219	110	137	69	88	0,657
125	3080020	125	237	125	148	74	79	0,811
150	3080021	160	264	160	164	85	123	1,183
200 *	3080022							

* Available in Q1 2020

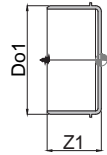

Wavin AS+ End cap

Diam. DN	Article Nr.	Do1 mm	Z1 mm	Weight kg/PC
50	3080106	50	51	0,055
70	3080107	75	55	0,108
90 *	3080108	90	60	0,186
100	3080103	110	65	0,290
125	3080104	125	68	0,360
150	3080105	160	76	0,565

* Available in Q1 2020

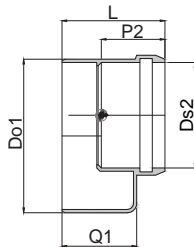

Wavin AS Reducer

Diam. DN	Article Nr.	Do1 mm	L mm	Ds2 mm	P2 mm	Q1 mm	Weight kg/PC
70/50	3080085	75	79	51	48	68	0,151
90/50 *	3080086	90	86	51	19	72	0,222
90/70 *	3080087	90	85	76	52		0,193
100/50	3080078	110	90	51	53	79	0,356
100/70	3080079	110	90	76	57	79	0,334
100/90	3080080	110	91	90	61	78	0,328
125/100	3080081	125	99	111	59		0,371
150/100	3080082	160	114	111	59	98	0,691
150/125	3080083	160	114	126	63	98	0,706
200/150 *	3080084	200	130	160	24	114	1,022

* Available in Q1 2020

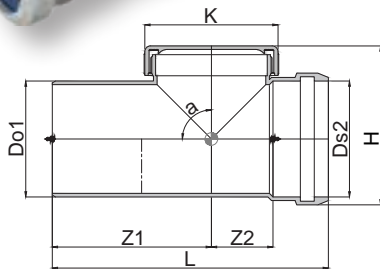

Wavin AS+ Access Piece

Diam. DN	a	Article Nr.	Do1 mm	L mm	Ds2 mm	Z1 mm	Z2 mm	K mm	H mm	Weight kg/PC.
50		3079917	50	164	50	82	37	65	84	
70		3079918	75	200	76	97	53	93	111	
90 *		3079949	90	228	90	114	62	111	131	
100		3079913	110	258	110	129	72	130	156	
125		3079914	125	259	125	127	71	130	174	
150		3079915	160	271	160	135	68	130	213	
200 *		3079916								

* Available in Q1 2020

ACCESSORIES

Wavin AS+ LKS-Clamp



Diam. DN	Article Nr.
50	4065138
70	4065139
90 *	4065140
100	4065141
125	4065142
150	4065143
200 *	4065144

* Available in Q1 2020

Gasket > EPDM



Diam. DN	Article Nr.
50	4065145
70	4065186
90	4065187
100	4065188
125	4065189
150	4065190
200	4065191



Gasket > NBR

Diam. DN	Article Nr.
50	4065192
70	4065193
90	4065194
100	4025566
125	4025567
150	4025568
200	4025569



Wavin system bracket

Diam. DN	Article Nr.
50	4066449
70	4066450
90	4066451
100	4066452
125	4066453
150	4066454
200	4066455



Rubber for traps

Diam. DN	Article Nr.
53 – 1¼"	4024657
53 – 1½"	4024658

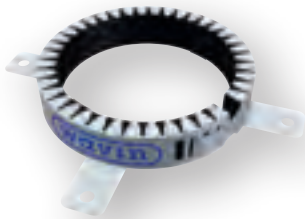

Firecollar BM-R90

Diam. DN	Article Nr.
32	4059802
40	4026101
50	4026102
63	4026103
75	4026104
90	4026405
110	4026106
125	4026107
140	4026108
160	4026109
180	4026110
200	4026111



EPDM Flex coupler for connecting AS with AS+

Diam. DN	Article Nr.
58-50	4066491
78-75	4066492
135-125	4066493

Annex I

Chemical resistance list

Legend

- +** = Resistant
- o** = Limited resistance
- = Not resistant
- SA** = Saturated, aqueous solutions
- TP** = Technically pure
- D** = Diluted
- C** = Commercial



Corrosive agent	Concentration	20°C PP	40°C PP	60°C PP
Acetaldehyde	TP	o	-	
Acetic acid	60%	+	+	
Acetic acid	10%			
Acetic acid	25%			
Acetic acid	60-95%	o		
Acetic anhydride	TP	+		
Acetone	TP	+	+	
Acetophenone	TP	+	o	
Acrylonitrile	TP	+	+	
Adipic acid	SA	+	+	
Air	-	+	+	+
Allyl alcohol	96%	+	+	+
Aluminium chloride	SA	+	+	
Aluminium fluoride	SA			
Aluminium sulphate	SA	+	+	
Alums	SA	+	+	
Ammonia, aqueous	SA	+	+	
Ammonia, gas	TP	+	+	
Ammonia, liquid	TP	+		
Ammonium acetate	SA	+	+	
Ammonium carbonate and bi	SA	+	+	
Ammonium chloride	SA			
Ammonium fluoride	20%			

Corrosive agent	Concentration	20°C PP	40°C PP	60°C PP
Ammonium fluoride	SA	+	+	
Ammonium fluoride	>10%			
Ammonium hydroxide	SA	+	+	
Ammonium nitrate	SA			
Ammonium phosphate, including meta	SA	+	+	+
Ammonium sulphide	SA	+	+	
Amyl acetate	TP	o		
Amyl alcohol	TP	+	+	+
Aniline	SA			
Aniline	TP	o	o	
Aniline hydrochloride	SA	+	+	
Anisole	TP	+	o	
Anthraquinone sulphonic acid, suspension	SA			
Antimony trichloride	90%	+		
Apple juice	C	+		
Aqua regia (HCl/HNO3)	03:01	-	-	-
Arsenic acid	SA			
Barium salts	SA	+	+	+
Beer	C	+	+	
Benzaldehyde	0.1%	+	+	
Benzaldehyde	TP			
Benzine — super (fuel for internal combustion engines)	C	o	-	-
Benzine (cleaning agent)	C	o		
Benzine-benzol mixture	80/20	o	-	-
Benzoic acid	SA	+	+	
Benzol	TP	o	-	-
Benzoyl chloride	TP	o		
Benzyl alcohol	TP	+	o	
Borax	D	+	+	
Borax	SA			
Boric acid	SA	+	+	
Brandy	C	+		
Bromic acid	10%			
Bromine gas	-	o	-	-
Bromine water	SA	o	-	-
Bromine, gas, dry	TP			
Bromine, liquid	TP	-	-	-
Butadiene	TP	o	-	-
Butane, gas	TP	+		
Butanol	TP	+	o	o
Butyl acetate	TP	o	-	-
Butyl glycol (butane diol)	TP	+		
Butyl phenol	SA	+		
Butyl phenol	TP			
Butyl phthalate	TP	+	o	o
Butyric acid	20%	+		
Butyric acid	TP			
Calcium carbonate	SA	+	+	+
Calcium chlorate	SA			
Calcium chloride	SA	+	+	+
Calcium hydroxide	SA			
Calcium hypochloride	SA	+		
Calcium nitrate	50%			
Calcium nitrate	SA	+	+	
Calcium sulphate	SA			
Calcium sulphide	SA			
Camphor oil	TP	-	-	-
Carbon dioxide	100%			
Carbon dioxide	SA	+	+	
Carbon dioxide, gas, wet/dry	TP	+	+	
Carbon disulphide	TP	+	-	-
Carbon monoxide	TP			
Carbon tetrachloride	TP	-	-	-
Castor oil	TP	+	+	
Caustic soda solution	Up to 60%	+	+	+
Caustic soda, see caustic soda solution		+	+	+
Chlorinated lime, slurry	-			
Chlorine ethanol	TP	+	+	
Chlorine water	SA	+	o	
Chlorine, gas, dry	TP	-	-	-
Chlorine, liquid	TP	-	-	-

Corrosive agent	Concentration	20°C PP	40°C PP	60°C PP	Corrosive agent	Concentration	20°C PP	40°C PP	60°C PP
Chloroacetic acid	85%	+	+		Hydrobromic acid	TP			
Chloroacetic acid	TP				Hydrochloric acid	20%	+	+	
Chloromethane	TP				Hydrochloric acid	Up to 35%	+	0	0
Chlorosulphonic acid	D	-	-	-	Hydrochloric acid, aqueous	Conc.			
Chlorosulphonic acid	TP				Hydrocyanic acid	10%	+	+	
Chrome alum	SA	+	+		Hydrofluoric acid	40%	+	+	
Chromic acid	1-50%	+	0	-	Hydrofluoric acid	70%	+	0	
Citric acid	D	+	+	+	Hydrogen	TP	+	+	
Citric acid	SA				Hydrogen chloride gas, dry	TP	+	+	
Coconut oil	TP	+			Hydrogen chloride gas, wet	TP	+	+	
Cooking salt, see sodium chloride		+	+	+	Hydrogen peroxide	30%	+	0	
Copper chloride	SA	+	+		Hydrogen peroxide	90%			
Copper cyanide	SA	+	+		Hydrogen sulphide	100%			
Copper fluoride	2%				Hydrogen sulphide	SA			
Copper nitrate	30%	+	+	+	Hydrogen sulphide	TP	+	+	
Copper nitrate	SA				Iodine tincture	C	+	0	
Copper sulphate	SA	+	+		I-propanol, see isopropanol		+	+	
Cotton-seed oil	TP	+	+		Iron II chloride	SA	+	+	
Cresol	Up to 90%	+	+		Iron II sulphate	SA			
Cresol	>90%	+			Iron III chloride	SA	+	+	
Cresylic acid	SA				Iron III nitrate	D			
Crotonic aldehyde	TP	+			Iron III sulphate	SA			
Cyclohexane	TP	+			Isopropanol	TP	+	+	+
Cyclohexanol	TP	+	0		Isopropyl ether	TP	0	-	
Cyclohexanone	TP	0	-	-	Lactic acid	10%			
Decahydronaphthalene (decalin)	TP	0	-	-	Lactic acid	TP			
Developers	C				Lanolin (wool fat)	C	+	0	
Dextrin	D	+	+		Lead acetate	SA	+	+	0
Dibutyl phthalate	TP	+	0	-	Linseed oil	TP	+	+	+
Dichloroacetic acid	TP	0			Magnesium carbonate	SA	+	+	+
Dichloroethylene	TP	0			Magnesium chloride	SA	+	+	+
Dichloromethane (methylene chloride)	TP	0	-	-	Magnesium hydroxide	SA	+	+	
Diethanolamine	TP	+			Magnesium nitrate	SA	+	+	
Diethyl ether	TP	+	0		Magnesium sulphate	SA	+	+	+
Diglycolic acid	30%				Maize germ oil	TP	+		
Diglycolic acid	SA	+	+		Maleic acid	SA	+	+	
Diisooctyl phthalate	TP				Malic acid	SA	+		
Dimethylamine	30%				Mercuric chloride	SA	+	+	
Dimethylamine	TP	+			Mercuric cyanide	SA	+	+	
Dimethylformamide	TP	+	+		Mercuric nitrate	D	+	+	
Dioctyl phthalate	TP	+	0		Mercury	TP	+	+	
Dioxane	TP	0	0		Methanol (methyl alcohol)	TP	+	+	-
Disodium phosphate	SA	+	+		Methyl acetate	TP	+	+	
Drinking water, chlorinated	TP	+	+	+	Methyl bromide	TP	-	-	-
Ethanediol	TP	+	+	+	Methyl ethyl ketone	TP	+	+	
Ethanol	40%				Methyl methacrylate	TP			
Ethanol	TP	+	+	+	Methylamine	Up to 32%	+		
Ethanolamine	TP	+			Methylene chloride, see dichloromethane		0	-	-
Ether, see diethyl ether		+	0		Milk	C	+	+	+
Ethyl acetate	TP	0	-	-	Mineral oils	C			
Ethylene chloride, mono and di	TP	0	0		Mineral water	C	+	+	+
Ethylene glycol, see ethanediol		+	+	+	MolaSAes	C	+	+	+
Fluorine	TP	-			Naphtha	C	+	-	-
Fluorosilic acid	40%				Naphthalene	TP	+	-	-
Formaldehyde (formalin)	40%	+	+		Nickel salts	SA	+	+	
Formic acid	1-50%	+	+	0	Nicotinic acid	D			
Formic acid	TP	+	-		Nitric acid	10%	+	+	
Fructose	C	+	+	+	Nitric acid	25%			
Fruit juices	C	+	+		Nitric acid	Up to 40%			
Furfuryl alcohol	TP	+	0		Nitric acid	10-50%	0	-	-
Gelatine	D	+	+	+	Nitric acid	Over 50%	-	-	-
Glacial acetic acid	TP	+	0	-	Nitric acid	75%			
Glucose	20%	+	+	+	Nitric acid	98%			
Glucose	SA				Nitrobenzene	TP	+	0	
Glucose	D	+	+	+	N-propanol	TP	+	+	
Glycerin	TP	+	+	+	Oils and fats (vegetable/animal)	-	+	0	
Glycolic acid	30%	+			Oleic acid	TP	+	0	
Glycolic acid	SA	+	-		Olive oil	TP	+	+	0
Heptane	TP	+	0	-	Oxalic acid	SA	+	+	-
Hexadecanol	TP				Oxygen	TP			
Hexane	TP	+	0		Ozone	TP			
Hydrobromic acid	10%				Paraffin oil	TP	+	0	
Hydrobromic acid	50%	+	-	-	Peanut oil	TP	+	+	

Corrosive agent	Concentration	20°C PP	40°C PP	60°C PP	Corrosive agent	Concentration	20°C PP	40°C PP	60°C PP
Peppermint oil	TP	+			Sodium cyanide	SA			
Perchloric acid	10%				Sodium dichromate	SA	+	+	+
Perchloric acid	20%	+	+		Sodium fluoride	SA			
Perchloric acid	70%				Sodium hexacyanoferrate (II+III)	SA			
Perchloric acid, see perchloric acid					Sodium hydrogen sulphite (sodium bisulphate)	SA	+	+	+
Perhydrol, see hydrogen peroxide	30%		+	0	Sodium hydroxide, see caustic soda solution		+	+	+
Petroleum ether	TP	+	0		Sodium hypochlorite	13% effec. Chlorine	+	0	-
Phenol	D				Sodium nitrate	SA	+	+	
Phenol, aqueous	90%	+			Sodium nitrite	SA	+	+	
Phenylhydrazine	TP	0	0		Sodium orthophosphate	SA			
Phenylhydrazine chlorhydrate	TP	+	0	-	Sodium perborate	SA	+		
Phosphine	TP				Sodium phosphate	SA	+	+	
Phosphoric acid	50%				Sodium silicate (water glaSA)	D	+	+	
Phosphoric acid	Up to 85%	+	+	+	Sodium sulphate and bi	SA	+	+	
Phosphorus oxychloride	TP	0			Sodium sulphide	SA	+	+	
Phosphorus trichloride	TP	0			Sodium sulphite	40%	+	+	+
Picric acid	SA	+			Sodium thiosulphate	SA	+	+	
PotaSAium bichromate	40%				Soybean oil	TP	+	0	
PotaSAium bichromate	SA	+	+		Strength	D	+	+	
PotaSAium borate	SA	+	+		Sugar	SA	+	+	
PotaSAium bromate	SA				Sulphur dioxide, dry, wet	TP	+	+	
PotaSAium bromate	10%	+	+		Sulphur dioxide, liquid	TP	+		
PotaSAium bromide	SA	+	+		Sulphur trioxide	TP			
PotaSAium carbonate and bi	SA	+	+		Sulphuric acid	Up to 10%	+	+	-
PotaSAium chlorate	SA	+	+		Sulphuric acid	10-80%	+	+	
PotaSAium chloride	SA	+	+		Sulphuric acid	96%	0	-	
PotaSAium chromate	40%	+			Sulphurous acid	SA	+	+	
PotaSAium cyanide	>10%				Sulphurous acid	30%			
PotaSAium cyanide	SA	+	+		Tannic acid (tannin)	D	+	-	
PotaSAium fluoride	SA	+	+		Tartaric acid	D			
PotaSAium hexacyanoferrate (II+III)	SA				Tartaric acid	SA	+	-	
PotaSAium hydroxide	Up to 50%	+	+	+	Tetraethyl lead	TP	+		
PotaSAium hydroxide	60%				Tetrahydrofuran	TP	0	-	-
PotaSAium hydroxide solution, see potaSAium hydroxide					Tetrahydronaphthalene (tetralin)	TP	-	-	-
PotaSAium hypochloride	D				Thionyl chloride	TP	0	-	-
PotaSAium iodide	SA	+	+		Thiophene	TP	+	0	
PotaSAium nitrate (potash)	SA	+	+		Tin chloride II+IV	SA	+	+	
PotaSAium orthophosphate	SA				Toluene	TP	0	-	-
PotaSAium perchlorate	1%				Trichloroacetic acid	50%	+	+	
PotaSAium perchlorate	10%	+	+		Trichloroethylene	TP	-	-	-
PotaSAium perchlorate	SA				Tricresyl phosphate	TP	+	0	
PotaSAium permanganate	SA	+	-		Triethanolamine	D	-		
PotaSAium permanganate	20%				Trimethyl propane	Up to 10%			
PotaSAium persulphate	SA	+	+		Turpentine	TP	+	-	-
PotaSAium sulphate	SA	+	+		Urea	33%			
PotaSAium sulphide	D				Urea	>10%			
Potash, see potaSAium nitrate		+	+		Urea	SA	+	+	
Propane, gas	TP	+			Urine	C			
Propionic acid	50%	+			Vinegar (wine vinegar)	C	+	+	
Propionic acid	TP				Vinyl acetate	TP	+	0	
Pyridine	TP	0	0		Whisky	C	+		
Saccharic acid	SA	+	+		Wine vinegar	C	+	+	
Salicylic acid	SA				Wines and spirits	C	+		
Salt water, see sea water		+	+	+	Xylene	TP	0		
Sea water	C	+	+	+	Yeast	D	+		
Silicon acid	D				Yeast	SA	+		
Silicon oil	TP	+	+	+	Zinc carbonate	SA			
Silver acetate	SA				Zinc chloride	SA	+	+	
Silver cyanide	SA				Zinc oxide	SA	+	+	
Silver nitrate	SA	+	+	0	Zinc sulphate	SA	+	+	
Soap	D								
Soda, see sodium carbonate		+	+	0					
Sodium acetate	SA	+	+	+					
Sodium benzoate	SA	+	+						
Sodium bicarbonate	SA	+	+	+					
Sodium biphosphate	SA								
Sodium borate	SA	+	+						
Sodium bromide	SA								
Sodium carbonate	SA	+	+	0					
Sodium chlorate	SA	+	+						
Sodium chloride	SA	+	+	+					
Sodium chlorite	20%	+	0	-					

Annex II

Wavin AS+, low noise Soil & Waste specification clauses

CONTENTS LIST

- 1000 Application
- 2000 Supplier
- 3000 Materials
- 4000 Performance Objectives
- 5000 Installation
- 6000 Documents to be provided to client

WAVIN AS+, LOW NOISE SOIL & WASTE SYSTEM

1000 Application

- Soil and waste system

2000 Supplier

- Wavin

3000 Materials

- Pipe
 - Material: Mineral filled PP, density ~1,9 kg/dm³
 - Colour: Grey RAL 7035
 - Stiffness: > 4 kN/m²
- Fittings:
 - Material: Mineral filled PP, density ~1,9 kg/dm³
 - Colour: Grey RAL 7035
 - Seal: EPDM
- Outer diameters (mm) 50; 70; 90; 100; 125; 150

4000 Performances Objectives

- Noise barrier properties according to EN 14366 (Fraunhofer test P-BA 63/2019)
2 l/s WAVIN low noise bracket rubber lined metal bracket
 - 48 dB(A)
 - 12 dB(A)
- Air borne:
- Structure borne:
- Temperature resistance: The pipe system needs to be resistant against continuous temperatures of 90°C and peak temperatures of 95°

5000 Installation

- According to WAVIN AS+ Installation manual
- Bracket fixing instruction: Use full encircling metal brackets with rubber inserts.
Please use for correct installation the AS+ manual chapter 5 installation

6000 Documents to be provided to the client

Sound level: The contractor needs to demonstrate via an independent programme that the sound level in the rooms shall not exceed the required sound levels. Unless stated otherwise the maximum sound level is: 30 dB(A). Explanation: the sound level is dependent on amongst others the material of the pipe system, the wall thicknesses of the pipe and fittings, the diameter of the system, the flow capacity, the duct material and construction, the type of brackets and mass of the fixation wall and room size. When one of the variables changes, the calculation needs to be repeated with the new input values.

Discover our broad portfolio at wavin.com

Hot & Cold Water
Indoor Climate
Soil & Waste

Foul Water
Storm Water

Gas & Water Mains
Geotextiles



Wavin is part of Orbia, a community of companies working together to tackle some of the world's most complex challenges. We are bound by a common purpose: To Advance Life Around the World.



Wavin B.V. P.O. Box 173 | 8000 AD Zwolle | The Netherlands | Phone +31 (0)38 - 429 49 11
Internet www.wavin.com | E-mail info@wavin.com

Wavin operates a programme of continuous product development, and therefore reserves the right to modify or amend the specification of their products without notice. All information in this publication is given in good faith, and believed to be correct at the time of going to press. However, no responsibility can be accepted for any errors, omissions or incorrect assumptions.

© 2019 Wavin Wavin reserves the right to make alterations without prior notice. Due to continuous product development, changes in technical specifications may change. Installation must comply with the installation instructions.